

Legero
The Lighting Specialist

A I N E
A r c h i t e c t u r a l R a n g e

Since 2009

Being Specialist from Thought to Space



This image is of **Prismatic Diffuser**

Prismatic refers to the pattern of prism-like shapes with triangular bases. Each pattern on the light cover are used to disperse light into a spectrum and distribute the concentrated light source over a larger surface area.

Who are we

We are bringing light to life...

Legero started its journey a decade ago with a passion for making great lighting environments that brings a sense of warmth, comfort and joy. Whether it be residential, healthcare, commercial or institutional, we are devoted to developing innovative, exceptional quality lighting solutions with state of the art designs. Our passion for great lighting began with a desire to bring tranquility and well-being by bringing a little more light into people's lives.

Best Sellers

Legero
LED Lighting

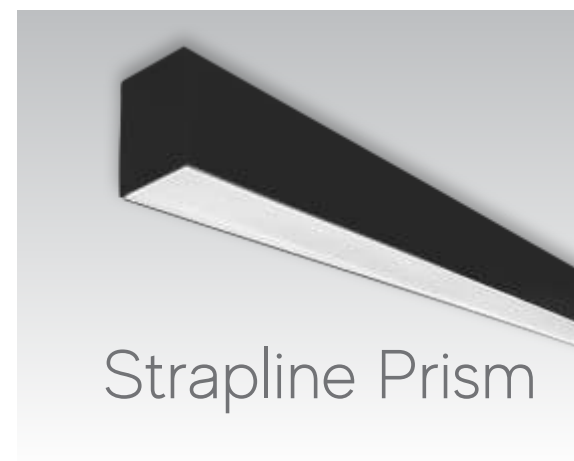
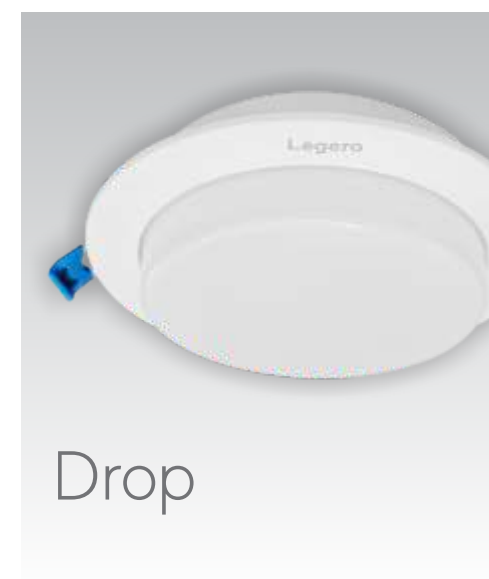
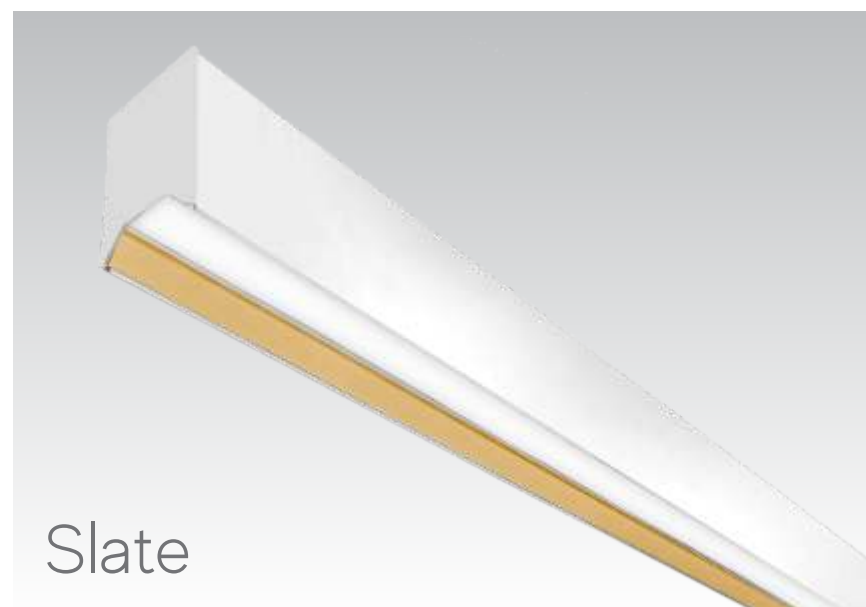
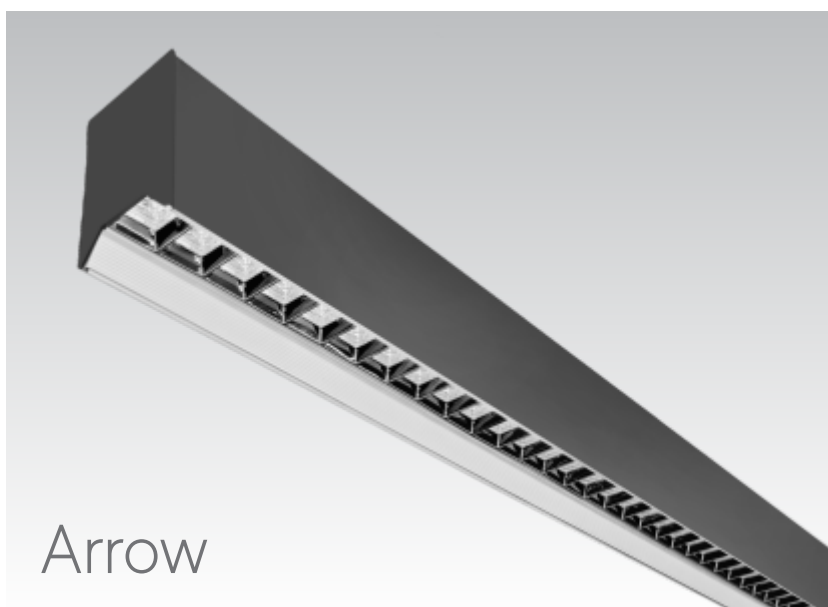



Task Us, Mohali



OP Jindal University, Haryana



IGI Airport Terminal - T3, Delhi

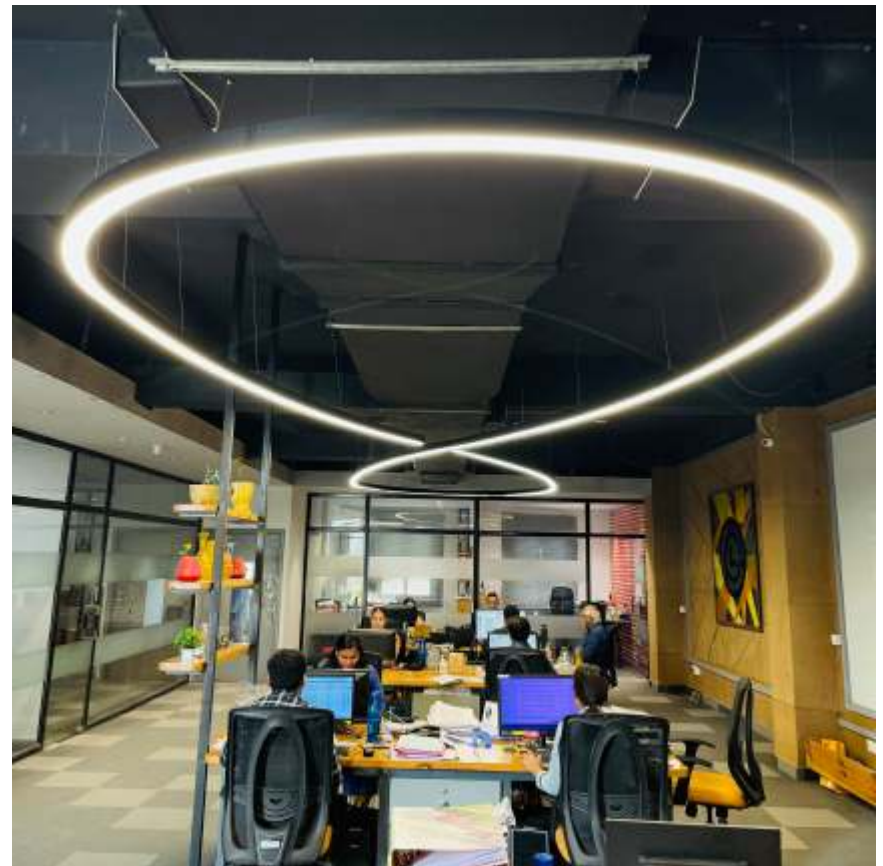

Legero H.O., Noida

Product Life Cycle

Design to Execution

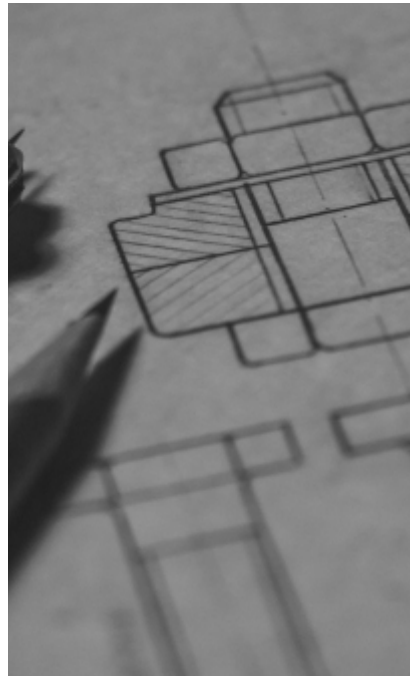

Designing

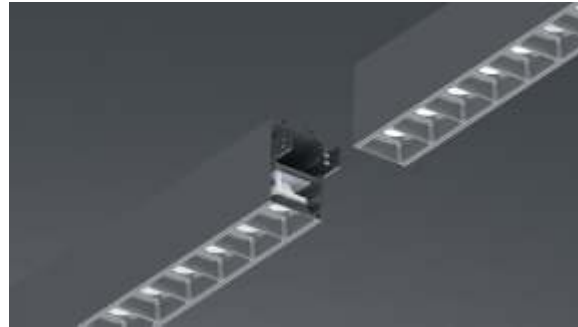

3D Modeling



Prototype



After Sales & Support



Logistics





Sampling



Goniophotometer



Integrating Sphere

Multiple Levels of Testing



Customized Solutions



Manufacturing

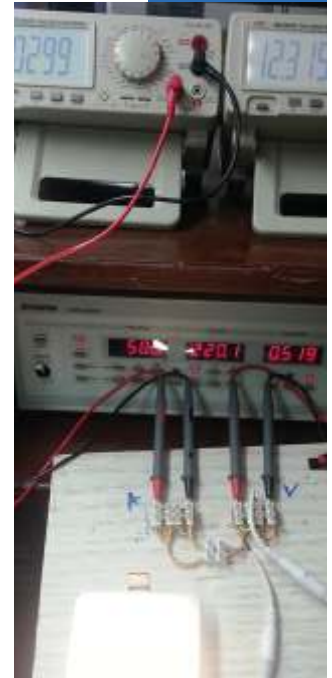

Our Structure and Facilities

We are a team of locally skilled craftsmen with a rigorous product validation process and QC standard to ensure the finest quality of the products. With updated machinery and equipment, it has eased achieving manufacturing efficiency.

The manufacturing plants are well-equipped with modern machinery for producing quality products. All the plants are ISO 9001: 2015, 14001: 2004, 18001: 2007 and ISO 45001 certified and perpetually upgraded to deliver quality outcomes and have an excellent safety record, making Legero the leader in this segment.

We are capable of executing projects of any scale with our current setup and bandwidth.

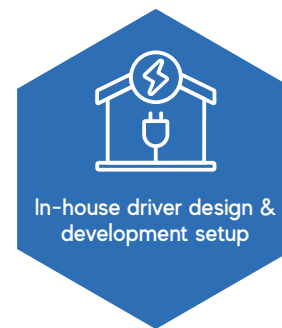
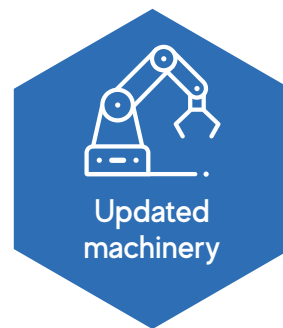

SMT Machine for In-house LED Mounting



CNC Engraver Machine



Curving Machine



In-house Driver Manufacturing

Want to know how to get the
perfect lighting for your home or office ?

**Get professional lighting support
from our experts.**



Product Symbol Glossary

 Grounding connection mark (class I protection)

 Class II protection against electrical shock

 Class III protection against electrical shock

DALI Luminaire dimming according to DALI protocol

1-10V Dimming of luminaire according 1-10V protocol

220-240V **12V** **24V** Rated voltage

RAL Powder coating of lighting fixtures in RAL scale colors

Ra>90 Color rendering index

HCL Human Centric Lighting

RF Build-in wireless control module

RGB Color-dynamic lighting

DMX Luminaire dimming according to DMX protocol

 Recess size

 Tilt angle

Ta(°C) **Ta(°C)** Ambient temperature
-10/+40 **-10/+50**

F<5% Luminous flux flickering

50/60 Hz Rated frequency of supply voltage

PR **OP** **CLR** Prismatic / Opal / Clear Diffuser
DIFFUSER **DIFFUSER** **DIFFUSER**

NEW New luminaires

CRI >90 High color rendering index > 90

CT CCT tunable luminaire

Wifi Wifi controlled lighting (Mobile App controlled)

TRAIC Triode For Alternating Current

IP 65 Ingress Protection

UGR <19 Unified Glare Rating

INDEX

ALINE RANGE

ARCHITECTURAL LUMINAIRES

Page 8-12



LINEAR FORMATION

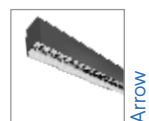

Arrow

Page 16-17

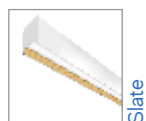

Slate

Page 18

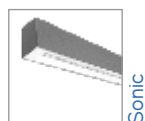

Sonic

Page 19

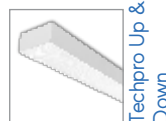

Techpro Up & Down

Page 20

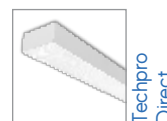

Techpro Direct

Page 21

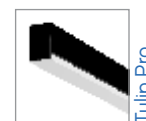

Tulip Pro

Page 22



Strapline Pro

Page 23



Strapline Pro Prism

Page 24



Strapline Prism Suspended

Page 24



Strapline Prism Recessed

Page 25



Strapline Up & Down

Page 25



Strapline 50S

Page 26



Strapline 50R

Page 26



Strapline 35S

Page 27



Strapline 35R

Page 27

SHAPES & FORMS



Ribbon

Page 29



Ripple

Page 30



Pill

Page 31



Pill Recessed

Page 32



Pill Surface

Page 33



Dice

Page 34



Drift

Page 35



Petal

Page 36



Trio

Page 37



Hexo

Page 38

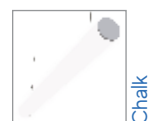

Chalk

Page 39

COMMERCIAL LUMINAIRES



Crysta

Page 41



Zen

Page 42



Terra 1X1,
2X2 & 1X4

Page 43



Terra Surface

Page 44



Modena Pro

Page 45

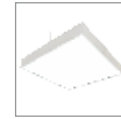

Moon Light
Suspended

Page 46



Moon Light
Linear 1
Suspended

Page 47

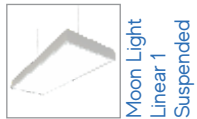

Moon Light
Linear 1
Suspended

Page 47



Tubo Surface
& Suspended

Page 48



Tubo-D
Surface &
Suspended

Page 49



Nora Surface
& Suspended

Page 50



Nora-D
Surface &
Suspended

Page 51

ACOUSTIC RANGE



Page 53



Page 53



Page 53



Page 53



Page 53



Page 53



Page 54



Page 54



Page 54



Page 54



Page 54



Page 54

Track Luminaires



Page 56



Page 56



Page 56



Page 56



Page 56



Page 56



Page 57



Page 57



Page 57



Page 57



Page 57



Page 57



Page 58



Page 58



Ace

Page 59

ARIES RANGE

RECESSED & SURFACE DOWNLIGHTS

Page 8-12



SPOTS

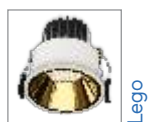

Lego

Page 62



Sol

Page 63



Nova

Page 64

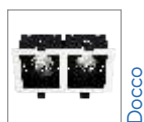

Docco

Page 65



Mika

Page 66



Vela

Page 67



Opal

Page 68



Avio

Page 69



Omega-R

Page 70



Sigma

Page 71

MINI SPOTS



Gia

Page 73



Mia

Page 74



Cribo

Page 75



Ziva

Page 76



Button

Page 77



Cell

Page 78

COMMERCIAL DOWNLIGHTERS

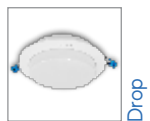

Drop

Page 80



Dart

Page 81



Oculus

Page 82



Omega

Page 83



Omega-R
Surface

Page 84



Omega-R
Suspended

Page 84



Omega-D

Page 85



Atmos Pro

Page 86



Atmos
Surface

Page 87



Pearl Pro

Page 88



Pearl (R)
Surface

Page 89



Pearl (Sq)

Page 90



Coral (R)

Page 91



Coral
Surface (R)

Page 92



Coral (Sq)

Page 93



Coral
Surface (Sq)

Page 94



Aline

Architectural Range

Architectural lighting works to serve and enhance the architecture, not merely as an accessory, to create a cohesive spatial experience. So, architectural lighting is an intersection of art (architecture) and technology (lighting). The architecture being illuminated or lighted may be commercial or residential.

Architectural lighting works to foster the spatial experience. Lighting can influence mood, texture, spatial awareness. Generally, lighting design should account for the specific type of action being illuminated; the amount of light provided, the color of the light, which may affect the optics for particular objects, such as works of art, and the overall, whole environment. Our latest range of products blends perfectly with modern architectural lighting concepts.



Linear Formation



NEW

Arrow

Architectural Luminaire

The extruded aluminium housing and Flange color available in Black/White/Grey finish this LED fixture comes with excellent light distribution and UGR <16 and Available beam angle 50°, 35° X 70°, 60° X 60° with Higher efficacy 120-125lm/W.

Features



Multilevel-optics
for optimized light
distribution

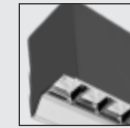

Aluminium extrusion
housing

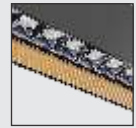

Available in different
Flange color options

Product Dimensions

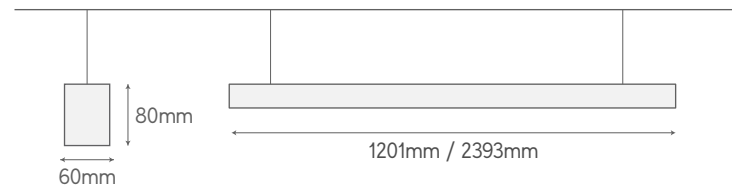

	WATTAGE	CODE	CCT	BEAM ANGLE	50°/60°X60° (B.A.) EFFICACY (lm/W)	36°X70° (B.A.) EFFICACY (lm/W)	P. F.
Direct	10W	LLS 1010	3000K/4000K/6000K	50°/60°X60°/36°X70°	115/120/125	105/110/115	≥0.95
	15W	LLS 1015	3000K/4000K/6000K	50°/60°X60°/36°X70°	115/120/125	105/110/115	≥0.95
	20W	LLS 1020	3000K/4000K/6000K	50°/60°X60°/36°X70°	110/115/120	105/110/115	≥0.95
	25W	LLS 1025	3000K/4000K/6000K	50°/60°X60°/36°X70°	110/115/120	105/110/115	≥0.95
Direct-Indirect	14W	LLSI 1014	3000K/4000K/6000K	50°/60°X60°/36°X70°	105/110/115	95/100/105	≥0.95
	23W	LLSI 1023	3000K/4000K/6000K	50°/60°X60°/36°X70°	105/110/115	95/100/105	≥0.95
	28W	LLSI 1028	3000K/4000K/6000K	50°/60°X60°/36°X70°	100/105/110	95/100/105	≥0.95
	35W	LLSI 1035	3000K/4000K/6000K	50°/60°X60°/36°X70°	100/105/110	95/100/105	≥0.95

110° Indirect
Beam Angle



Application Areas

- Offices
- Home
- Showrooms
- Banks
- Café & Restaurants
- Hospitals
- School / Institutes

Housing Color



Flange color



DALI

1-10V

Ta(°C)
-10/+40

F1<5%

50/60
HzCRI
>90UGR
<16

NEW

Slate

The extruded aluminium housing and Flange color available in grey, black & white. This LED fixture comes with excellent light distribution, high wired LED driver to be used in suspended applications with Higher efficacy 105-110lm/W. Direct-Indirect lighting ratio is 70:30 with wide beam angle.

Features

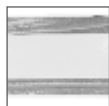

High Efficient Opal Diffuser



Aluminium extrusion housing



Available in different Flange color options

Product Dimensions

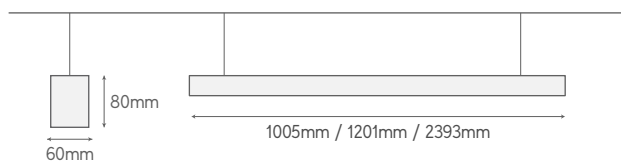

	WATTAGE	CODE	CCT	BEAM ANGLE	White Finish EFFICACY (lm/W)	Other Color Finish EFFICACY (lm/W)	P. F.
Direct	20W	LLF 1020	3000K/4000K/6000K	110°	100/105/110	90/95/100	≥0.95
	30W	LLF 1020	3000K/4000K/6000K	110°	100/105/110	90/95/100	≥0.95
Direct-Indirect	28W	LLFI 1020	3000K/4000K/6000K	110°	90/95/100	80/85/90	≥0.95
	42W	LLFI 1020	3000K/4000K/6000K	110°	90/95/100	80/85/90	≥0.95



Application Areas

- Offices
- Home
- Showrooms
- Banks
- Café & Restaurants
- Hospitals
- School / Institutes

Housing Color



Flange color



DALI

1-10V



F_r<5%

50/60 Hz



Sonic

Sonic a perfect suspended design with step in optics offering a combination of functionality and design. A linear lens combination gives a unique look to this product. A aesthetically pleasant product suitable in various applications like offices, restaurants, Showrooms etc.

Features

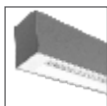

Aesthetically elegant & functional design



Improved efficiency & Uniform Light Distribution

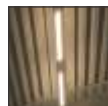

Better glare control

Product Dimensions

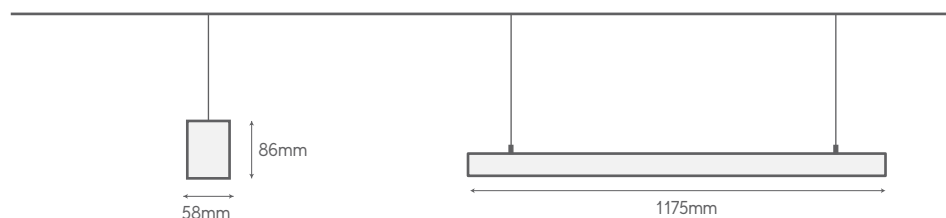

WATTAGE	CODE	CCT	BEAM ANGLE	EFFICACY (lm/W)	P. F.	LENGTH
25W	LPS 5025	3000K/4000K/6000K	100°	100/105/110	≥0.95	1175mm + Continuous
40W	LPS 5040	3000K/4000K/6000K	100°	90/95/100	≥0.95	1175mm + Continuous



Application Areas

- Offices
- Home
- Showrooms
- Banks
- Café & Restaurants
- Hospitals
- School / Institutes

Standard Colors



Specific Colors Available on Request



DALI

1-10V

RAL



F_i<5%

50/60 Hz



Techpro Up & Down

Suspended Up & Down single length individual luminaire, aluminium extruded powder coated housing with matt finish extruded PMMA opal diffuser with uniform light distribution.

Features



Extruded aluminium housing



Improved efficiency

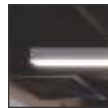

Glare free evenly distributed

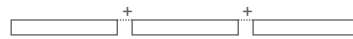

Customizable to varied lengths

Product Dimensions

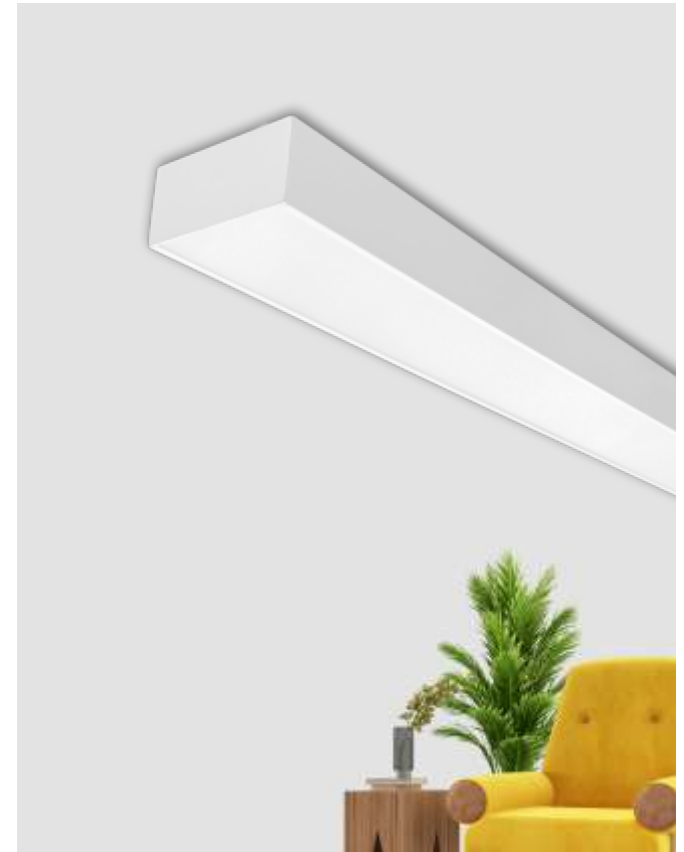
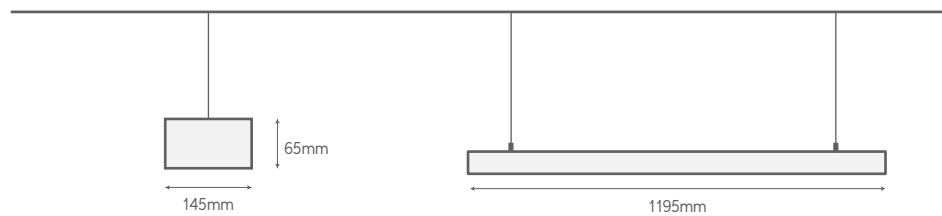

Opal
Diffuser

WATTAGE	CODE	CCT	BEAM ANGLE	EFFICACY (lm/W)	P. F.	LENGTH
35W	LTL 2035	3000K/4000K/6000K	110°	90/95/100	≥0.95	1195mm + Continuous

Prismatic
Diffuser

WATTAGE	CODE	CCT	BEAM ANGLE	White Finish EFFICACY (lm/W)	Other Color Finish EFFICACY (lm/W)	P. F.	LENGTH
35W	LTL 2035PR	3000K/4000K/6000K	90°	75/80/85	65/70/75	≥0.95	1195mm + Continuous



Application Areas

- Offices
- Home
- Showrooms
- Banks
- Café & Restaurants
- Hospitals
- School / Institutes

Standard Colors



Techpro Direct

Suspended mounting single length individual luminaire made up of aluminium extruded powder coated housing with matt finish & PMMA opal diffuser to give uniform light distribution.

Features



Extruded Aluminium Housing



Improved efficiency & Uniform Light Distribution



Compatible with Armstrong TECHZONE ceiling

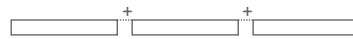

Customizable to varied lengths

Product Dimensions

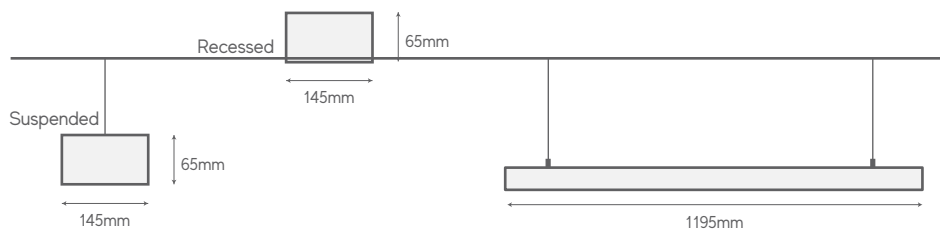

WATTAGE	CODE	CCT	BEAM ANGLE	EFFICACY (lm/W)	P. F.	LENGTH	Mounting Type
30W	LTL 1030	3000K/4000K/6000K	110°	100/105/110	≥0.95	1195mm + Continuous	Suspended
30W	LTL 1130	3000K/4000K/6000K	110°	100/105/110	≥0.95	1195mm + Continuous	Recessed

WATTAGE	CODE	CCT	BEAM ANGLE	EFFICACY (lm/W)	P. F.	LENGTH	Mounting Type
30W	LTL 1030PR	3000K/4000K/6000K	85°	90/95/100	≥0.95	1195mm + Continuous	Suspended
30W	LTL 1130PR	3000K/4000K/6000K	85°	90/95/100	≥0.95	1195mm + Continuous	Recessed

Opal Diffuser

Prismatic Diffuser



Application Areas

- Offices
- Home
- Showrooms
- Banks
- Café & Restaurants
- Hospitals
- School / Institutes

Standard Colors



DALI

1-10V

RAL



Ta(°C)
-10/+40

F_l<5%

50/60
Hz



OP
DIFFUSER



PR
DIFFUSER



CRI
>80



CRI
>90

Tulip Pro

Tulip a suspended extruded aluminium housing design offers improved uniformity with soft C profile LG7 diffuser lit on all three sides offering a soft homogeneous, volumetric light distribution snap fit diffuser for ease in maintenance With Higher efficacy 115-120lm/W

Features



Aesthetically elegant & functional design

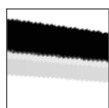

Improved efficiency & Uniform Light Distribution



Better glare control



Customizable to varied lengths

Product Dimensions

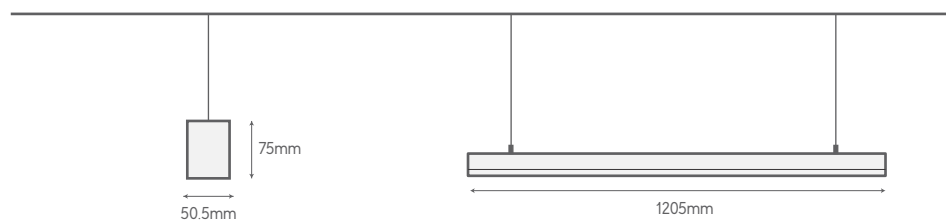

WATTAGE	CODE	CCT	BEAM ANGLE	EFFICACY (lm/W)	P. F.	LENGTH
15W	LSOP 5015	3000K/4000K/6000K	125°	110/115/120	≥0.95	1205mm + Continuous
20W	LSOP 5020	3000K/4000K/6000K	125°	110/115/120	≥0.95	1205mm + Continuous
25W	LSOP 5025	3000K/4000K/6000K	125°	110/115/120	≥0.95	1205mm + Continuous
30W	LSOP 5030	3000K/4000K/6000K	125°	110/115/120	≥0.95	1205mm + Continuous



Application Areas

- Offices
- Home
- Showrooms
- Banks
- Café & Restaurants
- Hospitals
- School / Institutes

Standard Colors



Specific Colors Available on Request



DALI

1-10V

RAL



Ta(°C)
-10/+40

F1<5%

50/60
Hz



OP
DIFFUSER



CRI
>80

Strapline Series

The extruded aluminium housing offers a precise in-line appearance. This LED fixture comes with excellent light distribution, high wired LED driver to be used in suspended applications with higher efficacy.

Features



Extruded aluminium housing



Stand alone or continuous mounting option



High Output Low Wattage

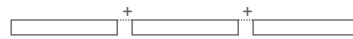

Customizable to varied lengths



Pro

Product Dimensions

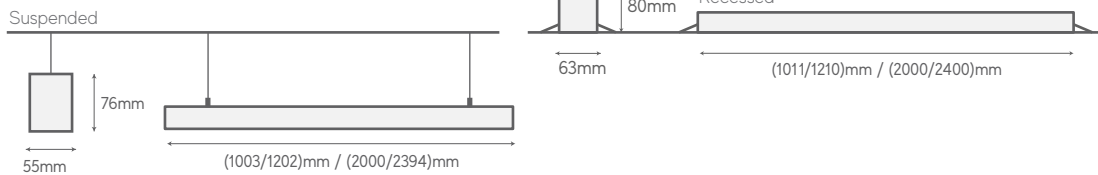

Application Areas

- Offices
- Home
- Showrooms
- Banks
- Café & Restaurants
- Hospitals
- School / Institutes

WATTAGE	CODE	CCT	BEAM ANGLE	White Finish	Black & Grey Finish	P. F.	LENGTH
				EFFICACY (lm/W(±5%))	EFFICACY (lm/W(±5%))		
15W	LSLP-R/(S) 5015	3000K/4000K/6000K	110°	115/120/125	105/110/115	≥0.95	1000mm/1200mm + Continuous
20W	LSLP-R/(S) 5020	3000K/4000K/6000K	110°	115/120/125	105/110/115	≥0.95	1000mm/1200mm + Continuous
25W	LSLP-R/(S) 5025	3000K/4000K/6000K	110°	110/115/120	100/105/110	≥0.95	1000mm/1200mm + Continuous
30W	LSLP-R/(S) 5030	3000K/4000K/6000K	110°	110/115/120	100/105/110	≥0.95	1000mm/1200mm + Continuous
30W	LSLP-R/(S) 5230	3000K/4000K/6000K	110°	115/120/125	105/110/115	≥0.95	2000mm/2400mm + Continuous
40W	LSLP-R/(S) 5240	3000K/4000K/6000K	110°	115/120/125	105/110/115	≥0.95	2000mm/2400mm + Continuous
50W	LSLP-R/(S) 5250	3000K/4000K/6000K	110°	110/115/120	100/105/110	≥0.95	2000mm/2400mm + Continuous
60W	LSLP-R/(S) 5260	3000K/4000K/6000K	110°	110/115/120	100/105/110	≥0.95	2000mm/2400mm + Continuous

Standard Colors



Specific Colors Available on Request

L & Y Connector for Formation



Pro Prism

Product Dimensions

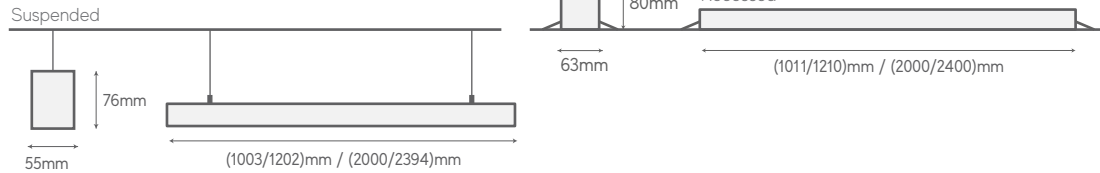

WATTAGE	CODE	CCT	BEAM ANGLE	White Finish	Black & Grey Finish	CRI	LENGTH
				EFFICACY (lm/W(±5%))	EFFICACY (lm/W(±5%))		
15W	LSP-R/(S) 5015PR	3000K/4000K/6000K	100°	105/110/115	95/100/105	>80	1000mm/1200mm + Continuous
20W	LSP-R/(S) 5020PR	3000K/4000K/6000K	100°	105/110/115	95/100/105	>80	1000mm/1200mm + Continuous
25W	LSP-R/(S) 5025PR	3000K/4000K/6000K	100°	100/105/110	90/95/100	>80	1000mm/1200mm + Continuous
30W	LSP-R/(S) 5030PR	3000K/4000K/6000K	100°	100/105/110	90/95/100	>80	1000mm/1200mm + Continuous
30W	LSP-R/(S) 5230PR	3000K/4000K/6000K	100°	105/110/115	95/100/105	>80	2000mm/2400mm + Continuous
40W	LSP-R/(S) 5240PR	3000K/4000K/6000K	100°	105/110/115	95/100/105	>80	2000mm/2400mm + Continuous
50W	LSP-R/(S) 5250PR	3000K/4000K/6000K	100°	100/105/110	90/95/100	>80	2000mm/2400mm + Continuous
60W	LSP-R/(S) 5260PR	3000K/4000K/6000K	100°	100/105/110	90/95/100	>80	2000mm/2400mm + Continuous

Prism Suspended

Product Dimensions

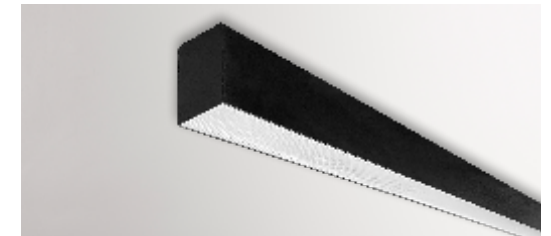
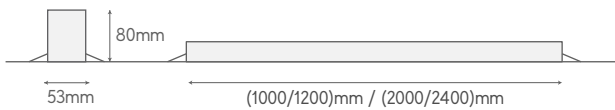

WATTAGE	CODE	CCT	BEAM ANGLE	EFFICACY (lm/W)	P. F.	LENGTH
10W	LSL-S5010PR	3000K/4000K/6000K	100°	75/80/85(W*) & 65/70/75(BG**)	≥0.95	500mm + Continuous
15W	LSL-S5015PR	3000K/4000K/6000K	100°	75/80/85(W*) & 65/70/75(BG**)	≥0.95	600mm/900mm + Continuous
20W	LSL-S5020PR	3000K/4000K/6000K	100°	75/80/85(W*) & 65/70/75(BG**)	≥0.95	1000mm/1200mm + Continuous
22W	LSL-S5022PR	3000K/4000K/6000K	100°	75/80/85(W*) & 65/70/75(BG**)	≥0.95	900mm + Continuous
25W	LSL-S5025PR	3000K/4000K/6000K	100°	75/80/85(W*) & 65/70/75(BG**)	≥0.95	1500mm + Continuous
30W	LSL-S5030PR	3000K/4000K/6000K	100°	75/80/85(W*) & 65/70/75(BG**)	≥0.95	1000mm/1200mm/1800mm + Continuous
37W	LSL-S5037PR	3000K/4000K/6000K	100°	75/80/85(W*) & 65/70/75(BG**)	≥0.95	1500mm + Continuous
40W	LSL-S5040PR	3000K/4000K/6000K	100°	75/80/85(W*) & 65/70/75(BG**)	≥0.95	2000mm/2400mm + Continuous
45W	LSL-S5045PR	3000K/4000K/6000K	100°	75/80/85(W*) & 65/70/75(BG**)	≥0.95	1800mm + Continuous
60W	LSL-S5060PR	3000K/4000K/6000K	100°	75/80/85(W*) & 65/70/75(BG**)	≥0.95	2000mm/2400mm + Continuous

Standard Colors



Specific Colors Available
on Request

L & Y Connector for Formation



Prism Recessed

Product Dimensions

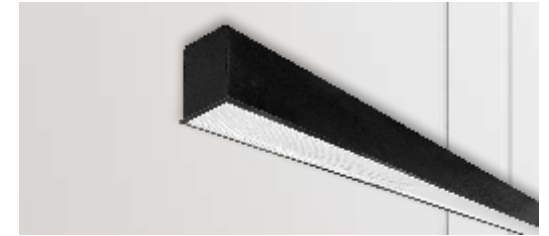
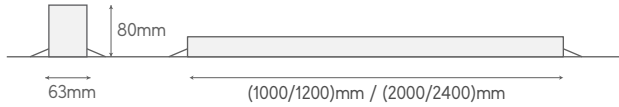

WATTAGE	CODE	CCT	BEAM ANGLE	EFFICACY (lm/W)	P. F.	LENGTH
10W	LSL-R5010PR	3000K/4000K/6000K	100°	75/80/85(W*) & 65/70/75(BG**)	≥0.95	500mm + Continuous
15W	LSL-R5015PR	3000K/4000K/6000K	100°	75/80/85(W*) & 65/70/75(BG**)	≥0.95	600mm/900mm + Continuous
20W	LSL-R5020PR	3000K/4000K/6000K	100°	75/80/85(W*) & 65/70/75(BG**)	≥0.95	1000mm/1200mm + Continuous
22W	LSL-R5022PR	3000K/4000K/6000K	100°	75/80/85(W*) & 65/70/75(BG**)	≥0.95	900mm + Continuous
25W	LSL-R5025PR	3000K/4000K/6000K	100°	75/80/85(W*) & 65/70/75(BG**)	≥0.95	1500mm + Continuous
30W	LSL-R5030PR	3000K/4000K/6000K	100°	75/80/85(W*) & 65/70/75(BG**)	≥0.95	1000mm/1200mm/1800mm + Continuous
37W	LSL-R5037PR	3000K/4000K/6000K	100°	75/80/85(W*) & 65/70/75(BG**)	≥0.95	1500mm + Continuous
40W	LSL-R5040PR	3000K/4000K/6000K	100°	75/80/85(W*) & 65/70/75(BG**)	≥0.95	2000mm/2400mm + Continuous
45W	LSL-R5045PR	3000K/4000K/6000K	100°	75/80/85(W*) & 65/70/75(BG**)	≥0.95	1800mm + Continuous
60W	LSL-R5060PR	3000K/4000K/6000K	100°	75/80/85(W*) & 65/70/75(BG**)	≥0.95	2000mm/2400mm + Continuous



Standard Colors



Specific Colors Available on Request

L & Y Connector for Formation



Up & Down

The extruded aluminium housing offers a precise in-line appearance. This LED fixture comes with Direct- Indirect light distribution, high wired LED driver to be used in suspended applications.

Product Dimensions

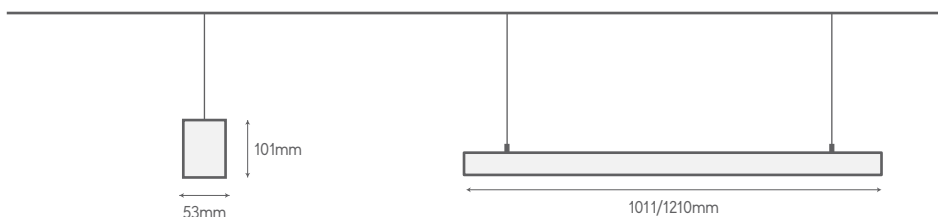

WATTAGE	CODE	CCT	BEAM ANGLE	EFFICACY (lm/W)*	P. F.	LENGTH
30W	LSL-S 5130	3000K/4000K/6000K	110°	80/85/90	≥0.95	1000mm/1200mm + Continuous
40W	LSL-S 5140	3000K/4000K/6000K	110°	80/85/90	≥0.95	1000mm/1200mm + Continuous

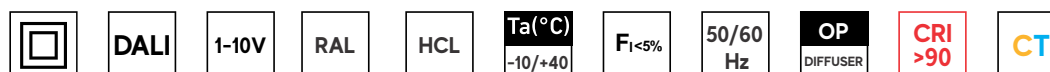

*Efficacy to be consider only for direct.

50S (Standard)

Product Dimensions

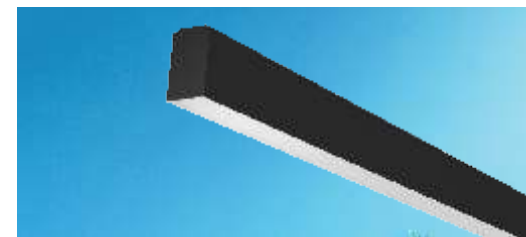
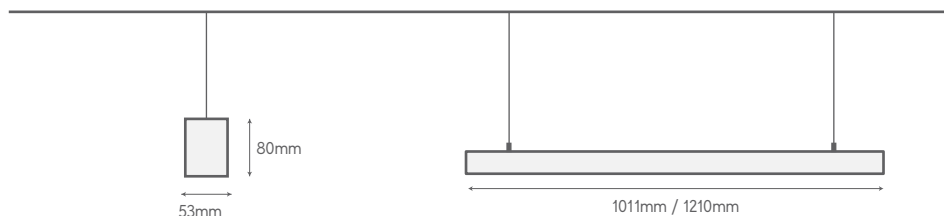

WATTAGE	CODE	CCT	BEAM ANGLE	EFFICACY (lm/W)	P. F.	LENGTH
20W	LSL-S 5020	3000K/4000K/6000K	110°	75/80/85	≥0.95	(1011/1210)mm / (2007/2402)mm + Continuous
30W	LSL-S 5030	3000K/4000K/6000K	110°	75/80/85	≥0.95	(1011/1210)mm / (2007/2402)mm + Continuous
40W	LSL-S 5040	3000K/4000K/6000K	110°	75/80/85	≥0.95	(1011/1210)mm / (2007/2402)mm + Continuous
60W	LSL-S 5060	3000K/4000K/6000K	110°	75/80/85	≥0.95	(1011/1210)mm / (2007/2402)mm + Continuous

50R (Standard)

Product Dimensions

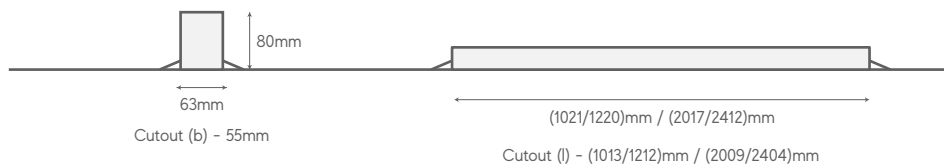

WATTAGE	CODE	CCT	BEAM ANGLE	EFFICACY (lm/W)	P. F.	LENGTH
20W	LSL-R 5020	3000K/4000K/6000K	110°	75/80/85	≥0.95	(1021/1220/2017/2412)mm + Continuous
30W	LSL-R 5030	3000K/4000K/6000K	110°	75/80/85	≥0.95	(1021/1220/2017/2412)mm + Continuous
40W	LSL-R 5040	3000K/4000K/6000K	110°	75/80/85	≥0.95	(1021/1220/2017/2412)mm + Continuous
60W	LSL-R 5060	3000K/4000K/6000K	110°	75/80/85	≥0.95	(1021/1220/2017/2412)mm + Continuous

Standard Colors



Specific Colors Available
on Request

L & Y Connector for Formation



35S (Standard)

Product Dimensions

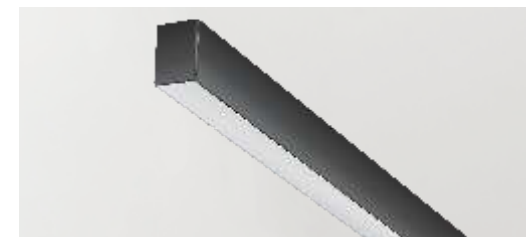
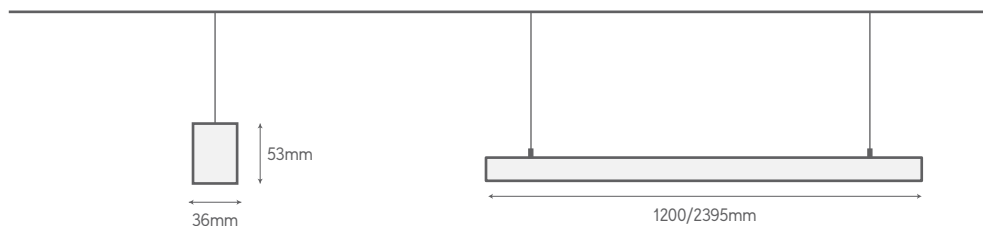

WATTAGE	CODE	CCT	BEAM ANGLE	EFFICACY (lm/W)	P. F.	LENGTH
20W	LSL-S 3520	3000K/4000K/6000K	110°	80/85/90	≥0.95	1200/2395mm + Continuous
30W	LSL-S 3530	3000K/4000K/6000K	110°	100/105/110	≥0.95	1200/2395mm + Continuous
40W	LSL-S 3540	3000K/4000K/6000K	110°	80/85/90	≥0.95	1200/2395mm + Continuous
60W	LSL-S 3560	3000K/4000K/6000K	110°	100/105/110	≥0.95	1200/2395mm + Continuous

35R (Standard)

Product Dimensions

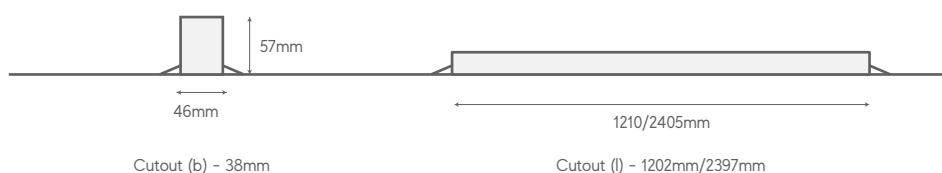

WATTAGE	CODE	CCT	BEAM ANGLE	EFFICACY (lm/W)	P. F.	LENGTH
20W	LSL-R 3520	3000K/4000K/6000K	110°	80/85/90	≥0.95	1210/2405mm + Continuous
30W	LSL-R 3530	3000K/4000K/6000K	110°	100/105/110	≥0.95	1210/2405mm + Continuous
40W	LSL-R 3540	3000K/4000K/6000K	110°	80/85/90	≥0.95	1210/2405mm + Continuous
60W	LSL-R 3560	3000K/4000K/6000K	110°	100/105/110	≥0.95	1210/2405mm + Continuous

Standard Colors



Specific Colors Available
on Request

L - Connector for Formation





SHAPES & FORMS



NEW

Ribbon

This contemporary aerial luminaire is a masterpiece that will add a swanky ambiance to your space. The LED fixture features excellent glare-free light distribution and lightweight extruded aluminium housing for an easy installation. Its sleek design and functionality blend in an incredibly eye-catching ribbon-like shape, making a dapper statement while saving you up to 80% on energy costs.

Features



Aesthetically elegant & functional design



Improved efficiency & Uniform Light Distribution



Bend it to any Formation



Customizable to varied lengths

Product Dimensions

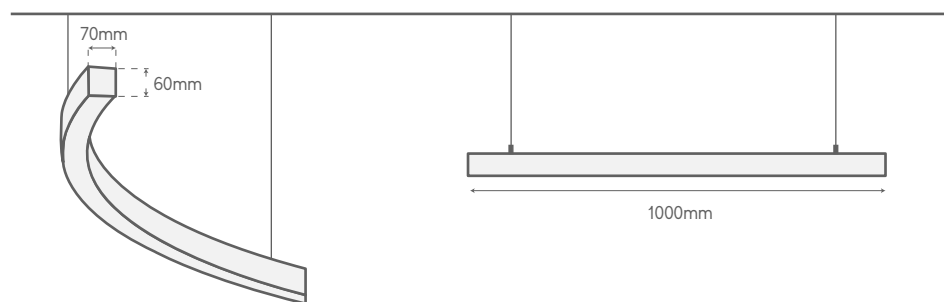

	WATTAGE	CODE	CCT	BEAM ANGLE	EFFICACY (lm/W)	P. F.	LENGTH
Opal Diffuser	20W	LSR 1020	3000K/4000K/6000K	110°	80/85/90	≥0.95	1000mm + Continuous
	30W	LSR 1030	3000K/4000K/6000K	110°	70/75/80	≥0.95	1000mm + Continuous
Prismatic Diffuser	20W	LSR 1020P	3000K/4000K/6000K	75°	65/70/75	≥0.95	1000mm + Continuous
	30W	LSR 1030P	3000K/4000K/6000K	75°	60/65/70	≥0.95	1000mm + Continuous



Application Areas

- Offices
- Home
- Showrooms
- Banks
- Café & Restaurants
- Hospitals
- School / Institutes

Standard Colors



Specific Colors Available on Request



DALI

1-10V

RAL

HCL

Ta(°C)
-10/+40

F_I<5%

50/60
Hz

OP
DIFFUSER

PR
DIFFUSER

CRI
>80

CRI
>90

CT

UGR
<19

Ripple

Round extruded aluminium housing with diffuser. Smart circular ring gives functional decorative look. Also diffuser is so fixed to provide uniform light output.

Features



Made of special aluminium bending technology



Laser cut HTF diffuser for improved efficiency



Aesthetically appealing

Product Dimensions

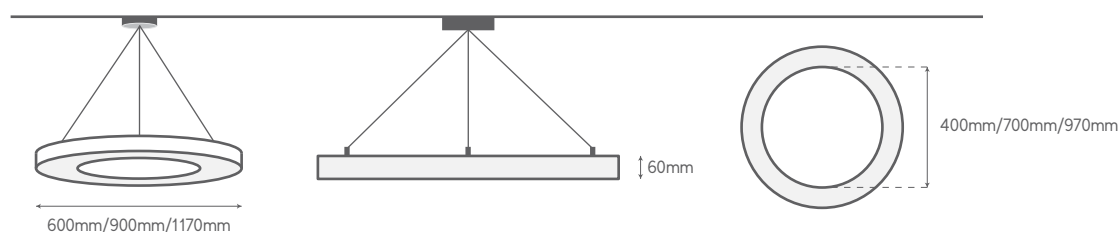

WATTAGE	CODE	CCT	BEAM ANGLE	EFFICACY (lm/W)	P. F.	Diameter
30W	ARL 6030	3000K/4000K/6000K	110°	65/70/75	≥0.95	600mm
55W	ARL 9055	3000K/4000K/6000K	110°	65/70/75	≥0.95	900mm
80W	ARL 12080	3000K/4000K/6000K	110°	65/70/75	≥0.95	1170mm
As per Request	ARL 6030	3000K/4000K/6000K	110°	65/70/75	≥0.95	1500mm
	ARL 9055	3000K/4000K/6000K	110°	65/70/75	≥0.95	1800mm
	ARL 12080	3000K/4000K/6000K	110°	65/70/75	≥0.95	2000mm
	ARL 12080	3000K/4000K/6000K	110°	65/70/75	≥0.95	2400mm



Application Areas

- Offices
- Home
- Showrooms
- Banks
- Café & Restaurants
- Hospitals
- School / Institutes

Standard Colors



DALI

1-10V

RAL



Ta(°C)
-10/+40

F₁<5%

50/60
Hz

OP
DIFFUSER

PR
DIFFUSER

CRI
>80

CRI
>90

Pill Suspended

Round extruded aluminium housing with PMMA diffuser. High efficient LEDs for uniform light distribution.

Features



Circular disk made of special aluminium bending technology



Special high efficiency diffuser designed for LED source



Aesthetically appealing

Product Dimensions

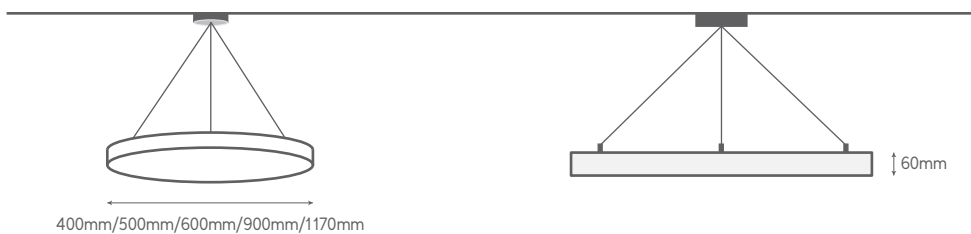

WATTAGE	CODE	CCT	BEAM ANGLE	EFFICACY (lm/W)	P. F.
30W	ALP-S 4130	3000K/4000K/6000K	110°	75/80/85	≥0.95
45W	ALP-S 5145	3000K/4000K/6000K	110°	65/70/75	≥0.95
56W	ALP-S 6156	3000K/4000K/6000K	110°	65/70/75	≥0.95
80W	ALP-S 9180	3000K/4000K/6000K	110°	65/70/75	≥0.95
100W	ALP-S 12100	3000K/4000K/6000K	110°	65/70/75	≥0.95



Application Areas

- Offices
- Home
- Showrooms
- Banks
- Café & Restaurants
- Hospitals
- School / Institutes

Standard Colors



DALI

1-10V

RAL

Ta(°C)
-10/+40

F₁<5%

50/60
Hz

OP
DIFFUSER

PR
DIFFUSER

CRI
>80

CRI
>90

Pill Recessed

Round luminaire aluminium, rolled profile, seamlessly welded housing with integrated tool-less suspension height adjustment. Highly reflective coating for improved efficiency with high transmission factor PMMA opal diffuser. Rolled aluminium frame accessory along with fixture for ease in installation.

Features



Circular disk made of special aluminium bending technology



Special high efficiency diffuser designed for LED source



Aesthetically appealing

Product Dimensions



415mm/515mm/615mm

Cutout (I) - 432/532/632



65mm

WATTAGE	CODE	CCT	BEAM ANGLE	EFFICACY (lm/W)	P. F.
30W	ALP-R 4230	3000K/4000K/6000K	110°	65/70/75	≥0.95
45W	ALP-R 5245	3000K/4000K/6000K	110°	60/65/70	≥0.95
56W	ALP-R 6256	3000K/4000K/6000K	110°	60/65/70	≥0.95



Application Areas

- Offices
- Home
- Showrooms
- Banks
- Café & Restaurants
- Hospitals
- School / Institutes

Standard Colors



Frame Accessory
Included



DALI

1-10V

RAL

Ta(°C)
-10/+40

F_l<5%

50/60
Hz

OP
DIFFUSER

CRI
>80

CRI
>90

Pill Surface

Round luminaire aluminium, rolled profile, seamlessly welded housing with integrated tool-less suspension height adjustment. Highly reflective coating for improved efficiency with high transmission factor diffuser. Rolled aluminium frame accessory along with fixture for ease in installation.

Features



Circular disk made of special aluminium bending technology

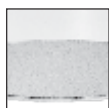

Special high efficiency diffuser designed for LED source



Aesthetically appealing

Product Dimensions



WATTAGE	CODE	CCT	BEAM ANGLE	EFFICACY (lm/W)	P. F.
30W	ASP 4330	3000K/4000K/6000K	110°	70/75/80	≥0.95
45W	ASP 5345	3000K/4000K/6000K	110°	65/70/75	≥0.95
50W	ASP 6350	3000K/4000K/6000K	110°	65/70/75	≥0.95
80W	ASP 9380	3000K/4000K/6000K	110°	65/70/75	≥0.95



Application Areas

- Offices
- Home
- Showrooms
- Banks
- Café & Restaurants
- Hospitals
- School / Institutes

Standard Colors



DALI

1-10V

RAL

Ta(°C)
-10/+40

F₁<5%

50/60
Hz

OP
DIFFUSER

PR
DIFFUSER

Opal
CRI
>80

Prism
CRI
>90

NEW

Dice

Dice suspended LED 2x2 luminaire made up of extruded aluminium With Round Corner to give a full glow effect with 95-100lm/W.

Features



Extruded Aluminium Housing



Efficient Light Output

Product Dimensions

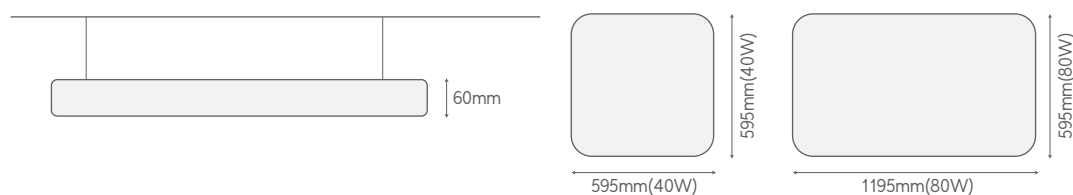

WATTAGE	CODE	CCT	BEAM ANGLE	White Finish EFFICACY (lm/W)	P. F.
40W	LSD 4040	3000K/4000K/6000K	110°	95/95/100	≥0.95
80W	LSD 4080	3000K/4000K/6000K	110°	95/95/100	≥0.95
40W	LSD 4040PR	3000K/4000K/6000K	110°	90/90/95	≥0.95
80W	LSD 4080PR	3000K/4000K/6000K	110°	90/90/95	≥0.95

Opal
Diffuser

Prismatic
Diffuser



Application Areas

- Offices
- Meeting Rooms
- Foyers and Lobbies
- Banks
- Café & Restaurants
- Hospitals
- Circulation Zones

Standard Colors



Drift

Round extruded aluminium housing with diffuser. Smart unique circular ring gives functional decorative look. Also diffuser is so fixed to provide uniform light output.

Features



Extruded Aluminium Housing



Efficient Light Output

Product Dimensions

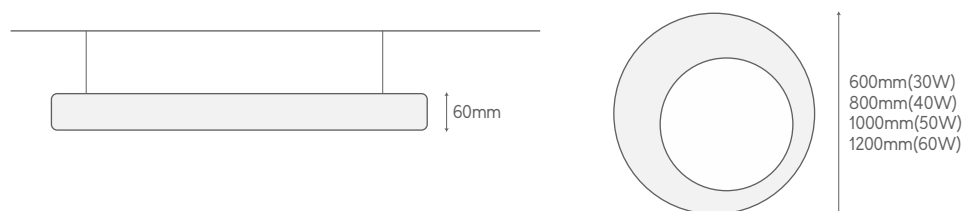

WATTAGE	CODE	CCT	BEAM ANGLE	White Finish EFFICACY (lm/W)	P. F.
30W	LSD 4040	3000K/4000K/6000K	110°	80/85/90	≥0.95
40W	LSD 4080	3000K/4000K/6000K	110°	80/85/90	≥0.95
50W	LSD 4040	3000K/4000K/6000K	110°	80/85/90	≥0.95
60W	LSD 4080	3000K/4000K/6000K	110°	80/85/90	≥0.95



Application Areas

- Offices
- Meeting Rooms
- Foyers and Lobbies
- Banks
- Café & Restaurants
- Hospitals
- Circulation Zones

Standard Colors



Petal

Extruded aluminium housing designed in leaf shape for unique & decorative look. High transmissivity diffuser is used to give smooth & glare free light output.

Features



Aluminium extrusion housing

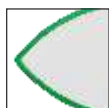

Laser cut HTF diffuser for improved efficiency



Aluminium extrusion housing

Product Dimensions

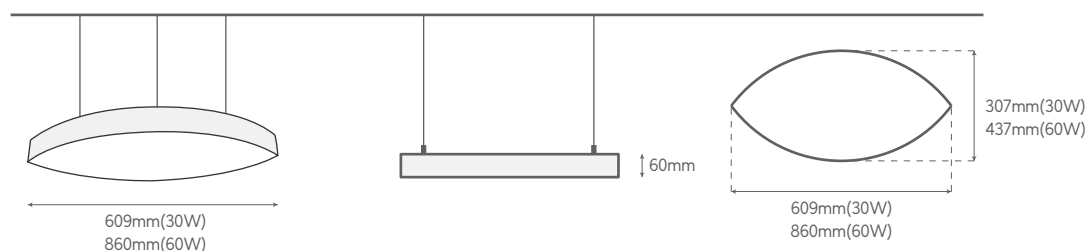

WATTAGE	CODE	CCT	BEAM ANGLE	EFFICACY (lm/W)	P. F.
30W	APL 6330	3000K/4000K/6000K	110°	70/75/80	≥0.95
60W	APL 6360	3000K/4000K/6000K	110°	70/75/80	≥0.95



Application Areas

- Offices
- Home
- Showrooms
- Banks
- Café & Restaurants
- Hospitals
- School / Institutes

Standard Colors



DALI

1-10V

RAL



Ta(°C)
-10/+40

F₁<5%



50/60
Hz



OP
DIFFUSER



PR
DIFFUSER



CRI
>80



CRI
>90

Trio

Triangular extruded aluminium housing with soft corner and high transmissivity diffuser. High efficient LEDs for uniform light.

Features

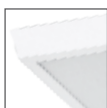

Aluminium extrusion housing



Especial PMMA diffuse designed for LED glare control



High Efficacy

Product Dimensions

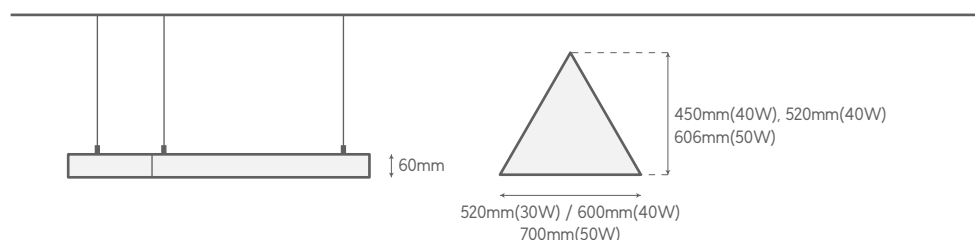

WATTAGE	CODE	CCT	BEAM ANGLE	EFFICACY (lm/W)	P. F.
30W	ATL-S 3030	3000K/4000K/6000K	110°	70/75/80	≥0.95
40W	ATL-S 3040	3000K/4000K/6000K	110°	70/75/80	≥0.95
50W	ATL-S 3050	3000K/4000K/6000K	110°	70/75/80	≥0.95



Application Areas

- Offices
- Home
- Showrooms
- Banks
- Café & Restaurants
- Hospitals
- School / Institutes

Standard Colors



Hexo

The extruded aluminium housing in hexagon shape with high transmissivity diffuser. High efficient LEDs for uniform light distribution.

Features



Aluminium extrusion housing



Especial PMMA diffuse designed for LED glare control



High Efficacy

Product Dimensions

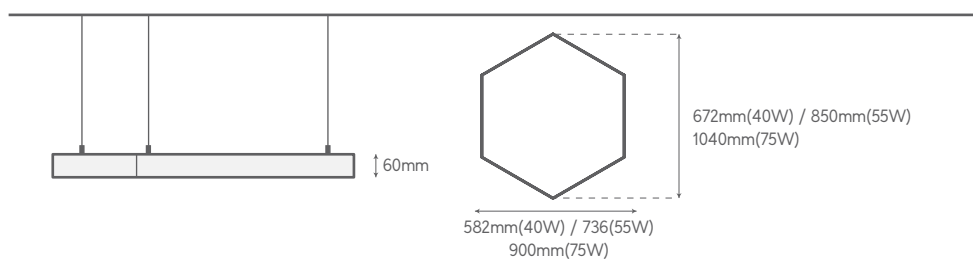

WATTAGE	CODE	CCT	BEAM ANGLE	EFFICACY (lm/W)	P. F.
40W	AHL 6040	3000K/4000K/6000K	110°	70/75/80	≥0.95
55W	AHL 6055	3000K/4000K/6000K	110°	70/75/80	≥0.95
75W	AHL 6075	3000K/4000K/6000K	110°	70/75/80	≥0.95



Application Areas

- Offices
- Home
- Showrooms
- Banks
- Café & Restaurants
- Hospitals
- School / Institutes

Standard Colors



NEW

Chalk

The Circular Polycarbonate Diffuser With aluminium End cap this LED fixture comes with excellent light distribution, high wired LED driver to be used in suspended applications With Higher efficacy 115-120lm/W.

Features



Aluminium
End Cap



Circular Polycarbonate
Diffuser

Product Dimensions

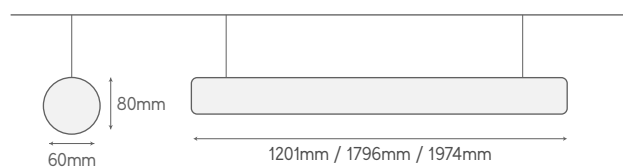

WATTAGE	CODE	CCT	BEAM ANGLE	White Finish EFFICACY (lm/W)	P. F.
20W/mtr.	LLC 2020	3000K/4000K/6000K	220°	100/105/110	≥0.95
30W/mtr.	LLC 2030	3000K/4000K/6000K	220°	100/105/110	≥0.95



Application Areas

- Offices
- Meeting Rooms
- Foyers and Lobbies
- Banks
- Café & Restaurants
- Hospitals
- Circulation Zones

Standard Colors





Commercial Luminaires

NEW

Crysta

Crysta Recessed CRCA housing design offers improved uniformity diffuser lit on all five sides and Drop-down diffuser follow the LG7 Guidelines and illuminates the Ceiling, Walls, Floor & Task area, Also illuminates the Ceiling, Walls, Floor & Task area with Higher efficacy 120-125lm/W.

Features



Drop-Down
Prism Shape
Diffuser



CRCA Housing

Product Dimensions

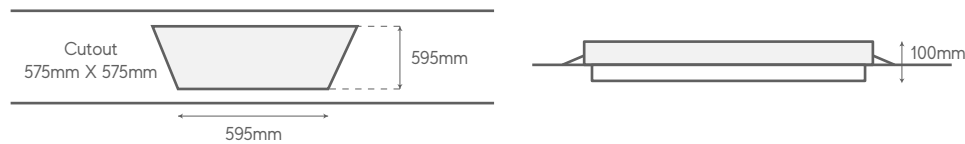

WATTAGE	CODE	CCT	BEAM ANGLE	EFFICACY (lm/W)	P. F.
28W	RCP 1028	3000K/4000K/6000K	120°	115/120/125	≥0.95
36W	RCP 1036	3000K/4000K/6000K	120°	110/115/120	≥0.95



Application Areas

- Offices
- Home
- Showrooms
- Banks
- Café & Restaurants
- Hospitals
- School / Institutes

Standard Colors



NEW

Zen

Recessed CRCA housing design offers improved uniformity diffuser lit on all five sides and Dropdown diffuser follow the LG7 Guidelines and illuminates the Ceiling, Walls, Floor & Task area, Also illuminates the Ceiling, Walls, Floor & Task area With Higher efficacy 115-120lm/W.

Features



Drop-Down
Diffuser



CRCA Housing

Product Dimensions

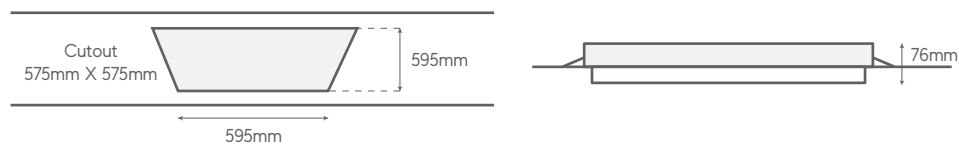

WATTAGE	CODE	CCT	BEAM ANGLE	EFFICACY (lm/W)	P. F.
28W	RMDP 1028	3000K/4000K/6000K	120°	110/115/120	≥0.95
36W	RMDP 1036	3000K/4000K/6000K	120°	105/110/115	≥0.95

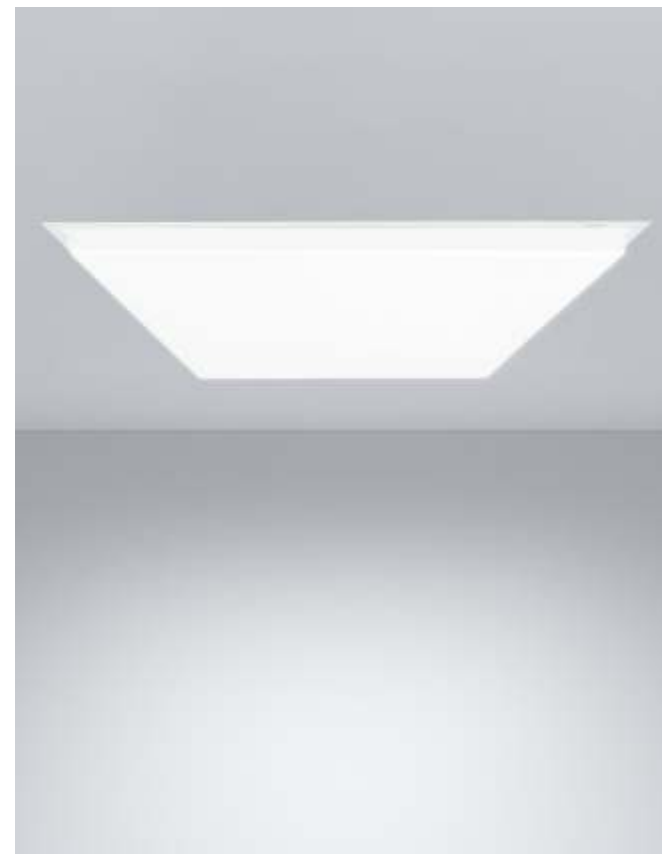

Application Areas

- Offices
- Home
- Showrooms
- Banks
- Café & Restaurants
- Hospitals
- School / Institutes

Standard Colors



Terra

1x1 & 2x2 Recess Mount LED Panel is a very nicely designed product with backlit technology & low height feature to provide high light output and premium aesthetic. It's suitable for the Armstrong/ Grid ceiling.

Features



Aesthetically elegant & functional design

Improved efficiency & Uniform Light Distribution

Product Dimensions

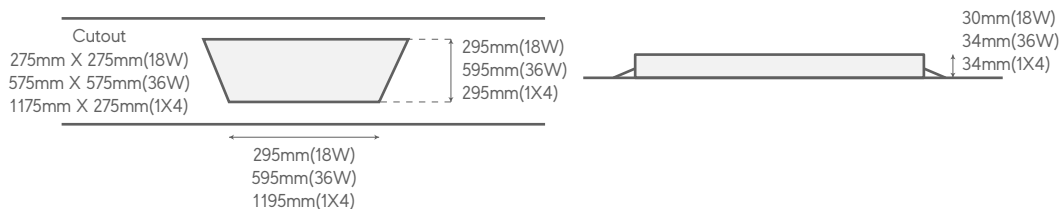

1X1

WATTAGE	CODE	CCT	BEAM ANGLE	EFFICACY (lm/W)	P. F.	Mounting Type
18W	LTP 1018	3000K/4000K/6000K	110°	80/85/90	≥0.97	Recessed

2X2

36W	LTP 1036	3000K/4000K/6000K	110°	90/95/100	≥0.97	Recessed
-----	----------	-------------------	------	-----------	-------	----------

1X4

36W	LTP 1136	3000K/4000K/6000K	110°	80/85/90	≥0.97	Recessed
-----	----------	-------------------	------	----------	-------	----------



Application Areas

- Offices
- Home
- Showrooms
- Banks
- Café & Restaurants
- Hospitals
- School / Institutes

Standard Colors



DALI

1-10V



Ta(°C)
-10/+40

F_r<5%

50/60
Hz



CRI
>80

NEW

Terra Surface

2x2 Surface Mount LED Panel is a very nicely designed product with backlit technology & low height feature to provide high light output and premium aesthetic. It's suitable for the Grid ceiling.

Features

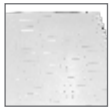

Made up of CRCA Sheet



Improved efficiency & Uniform Light Distribution

Product Dimensions

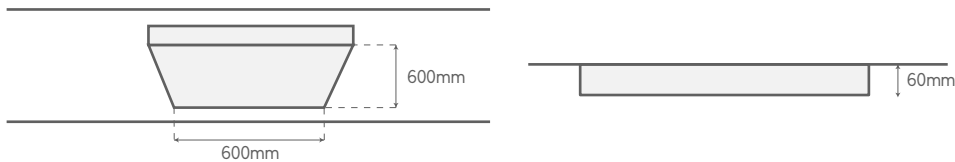

WATTAGE	CODE	CCT	BEAM ANGLE	EFFICACY (lm/W)	P. F.
36W	LTS 2036	3000K/4000K/6000K	110°	95/100/105	≥0.95

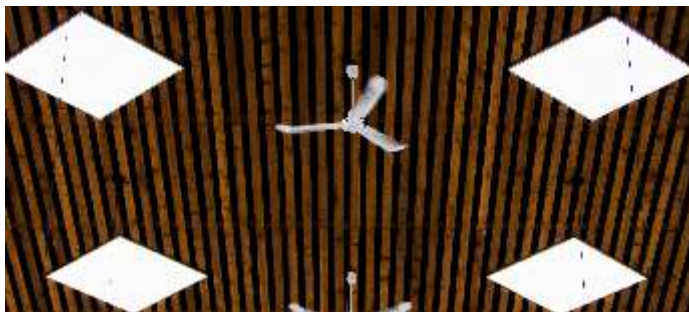
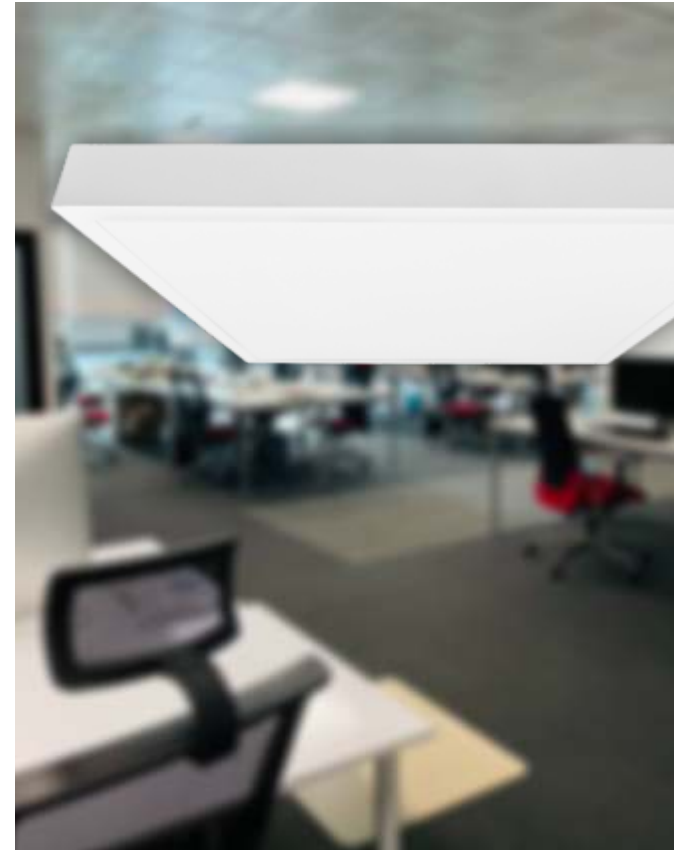

Application Areas

- Offices
- Home
- Showrooms
- Banks
- Café & Restaurants
- Hospitals
- School / Institutes

Available only White Finish



Ta(°C)
-10/+40

50/60
Hz

OP
DIFFUSER

CRI
>80

Modena Series

LED Panel Recessed Grid Ceiling Luminaire With opal Diffuser excellent uniform light with Higher efficacy.

Features



Aesthetically elegant
& functional design



Improved efficiency &
Uniform Light Distribution

Pro

Product Dimensions

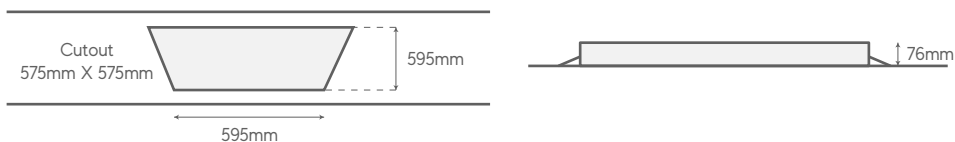

Application Areas

- Offices
- Home
- Showrooms
- Banks
- Café & Restaurants
- Hospitals
- School / Institutes

Standard Colors



Opal Diffuser

WATTAGE	CODE	CCT	BEAM ANGLE	EFFICACY (lm/W)	P. F.	Mounting Type
22W	LERP 2422	3000K/4000K/6000K	110°	125/130/135	≥0.97	Recessed
28W	LERP 2428	3000K/4000K/6000K	110°	125/130/135	≥0.97	Recessed
36W	LERP 2436	3000K/4000K/6000K	110°	120/125/130	≥0.97	Recessed

Prismatic Diffuser

WATTAGE	CODE	CCT	BEAM ANGLE	EFFICACY (lm/W)	P. F.	Mounting Type
22W	LERP 2422PR	3000K/4000K/6000K	90°	115/120/125	≥0.97	Recessed
28W	LERP 2428PR	3000K/4000K/6000K	90°	115/120/125	≥0.97	Recessed
36W	LERP 2436PR	3000K/4000K/6000K	90°	110/115/120	≥0.97	Recessed



Moon Light Series

A suspended LED luminaire made up of extruded aluminium to give a full glow effect with low glare diffuser and high efficient LEDs.

Features



Aesthetically elegant
& functional design



Improved efficiency &
Uniform Light Distribution



Suspended

Product Dimensions

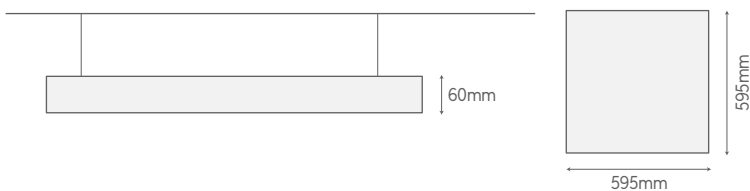

WATTAGE	CODE	CCT	BEAM ANGLE	EFFICACY (lm/W)	P. F.	Mounting Type
40W	LML 7040	3000K/4000K/6000K	110°	75/80/85	≥0.95	Suspended



Application Areas

- Offices
- Home
- Showrooms
- Banks
- Café & Restaurants
- Hospitals
- School / Institutes

Standard Colors



DALI

1-10V



Ta(°C)
-10/+40

F1<5%

50/60
Hz



OP
DIFFUSER



CRI
>80



CRI
>90

Linear 1 Suspended

Product Dimensions



WATTAGE	CODE	CCT	BEAM ANGLE	EFFICACY (lm/W)	P. F.	Mounting Type
45W	LML 7145	3000K/4000K/6000K	110°	75/80/85	≥0.95	Suspended

Linear 2 Suspended

Product Dimensions



WATTAGE	CODE	CCT	BEAM ANGLE	EFFICACY (lm/W)	P. F.	Mounting Type
80W	LML 7280	3000K/4000K/6000K	110°	75/80/85	≥0.95	Suspended

Standard Colors



DALI

1-10V

Ta(°C)
-10/+40

F₁<5%

50/60
Hz

OP
DIFFUSER

CRI
>80

CRI
>90

Tubo

Surface mount cylindrical COB downlight with extruded aluminum housing & die casted heat sink. It has efficient COB & reflector for better light distribution suitable for retail, hospitality & residential application area.

Features



Extruded Aluminium Body



High Efficient COB

Surface

Product Dimensions

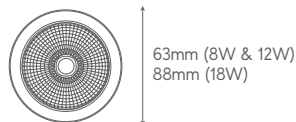
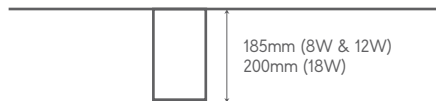

WATTAGE	CODE	CCT	BEAM ANGLE	EFFICACY (lm/W)	P. F.
8W	LRS 3308	3000K/4000K/6000K	15°/24°/36°/50°/60°	95/100/105	≥0.98
12W	LRS 3312	3000K/4000K/6000K	15°/24°/36°/50°/60°	90/95/100	≥0.95
18W	LRS 3318	3000K/4000K/6000K	15°/24°/36°/50°/60°	80/85/90	≥0.95

Suspended

Product Dimensions

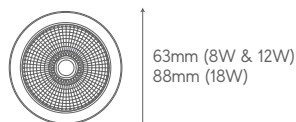
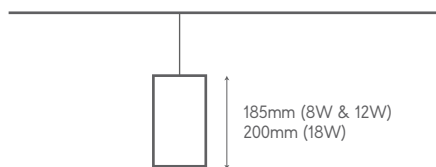

WATTAGE	CODE	CCT	BEAM ANGLE	EFFICACY (lm/W)	P. F.
8W	LRS-S 3308	3000K/4000K/6000K	15°/24°/36°/50°/60°	95/100/105	≥0.98
12W	LRS-S 3312	3000K/4000K/6000K	15°/24°/36°/50°/60°	90/95/100	≥0.95
18W	LRS-S 3318	3000K/4000K/6000K	15°/24°/36°/50°/60°	80/85/90	≥0.95

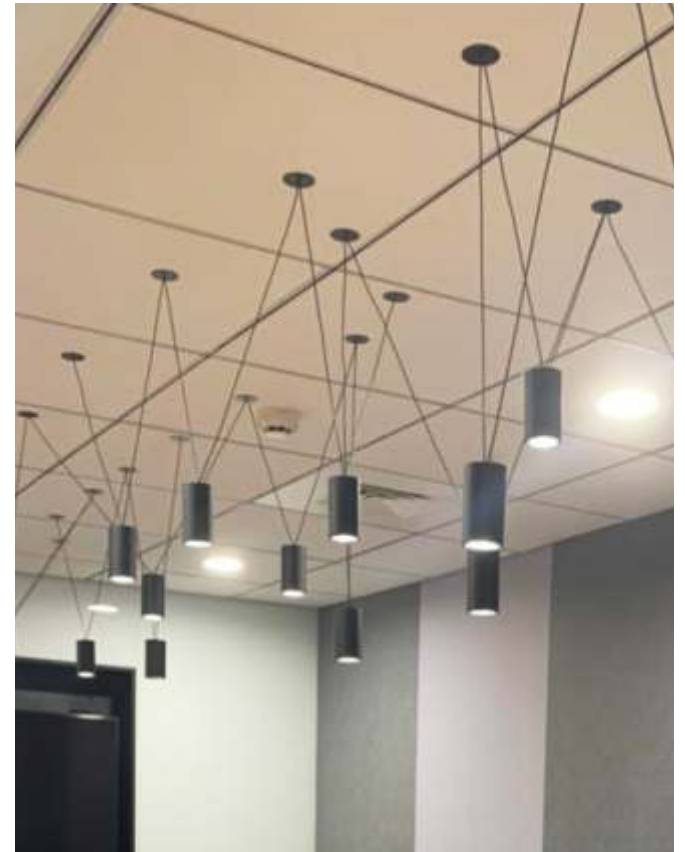

Application Areas

- Offices
- Home
- Showrooms
- Banks
- Café & Restaurants
- Hospitals
- School / Institutes

Standard Colors



■ Turbo-D

Surface/Suspended mount cylindrical COB downlight with extruded aluminum housing & die casted heat sink. It has Diffused light with efficient COB & reflector for better light distribution suitable for retail, hospitality & residential application area.

Features



Extruded
Aluminium Body



High Efficient
COB

□ Surface

Product Dimensions

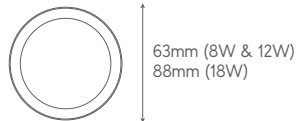
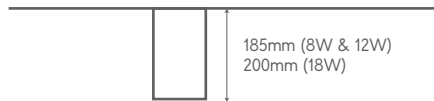

WATTAGE	CODE	CCT	BEAM ANGLE	EFFICACY (lm/W)	P. F.
8W	LRS 3408	3000K/4000K/6000K	100°	70/75/80	≥0.98
12W	LRS 3412	3000K/4000K/6000K	100°	70/75/80	≥0.95
18W	LRS 3418	3000K/4000K/6000K	100°	75/80/85	≥0.95

□ Suspended

Product Dimensions

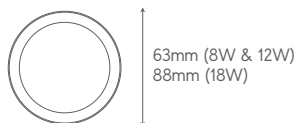
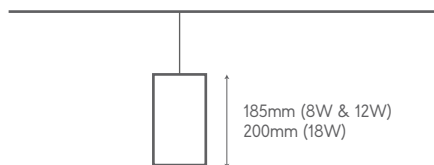

WATTAGE	CODE	CCT	BEAM ANGLE	EFFICACY (lm/W)	P. F.
8W	LRS-S 3408	3000K/4000K/6000K	100°	70/75/80	≥0.98
12W	LRS-S 3412	3000K/4000K/6000K	100°	70/75/80	≥0.95
18W	LRS-S 3418	3000K/4000K/6000K	100°	75/80/85	≥0.95

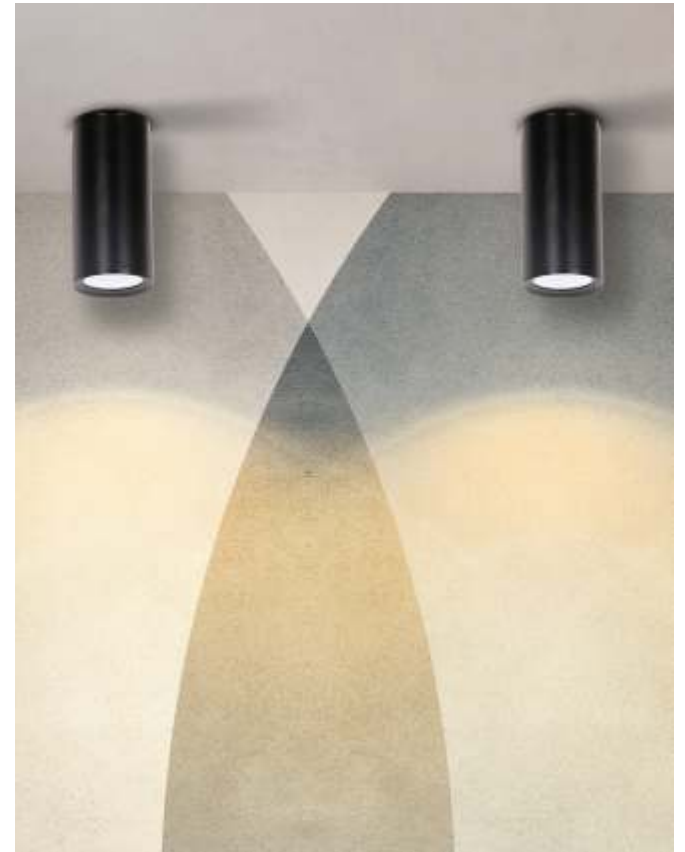

Application Areas

- Offices
- Home
- Showrooms
- Banks
- Café & Restaurants
- Hospitals
- School / Institutes

Standard Colors



Ta(°C)
-10/+40

OP
DIFFUSER

50/60
Hz

CRI
>80

Nora

Surface mounted adjustable COB downlight with high efficient COB and reflector for better light distribution suitable for retail, hospitality and residential application area.

Features



Die-Cast
Aluminium & CRCA Body



High Efficient
COB

Surface

Product Dimensions

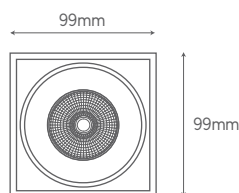
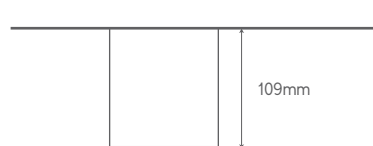

WATTAGE	CODE	CCT	BEAM ANGLE	EFFICACY (lm/W)	P. F.
10W	LDN 7110	3000K/4000K/6000K	50°	80/85/90	≥0.95

Suspended

Product Dimensions

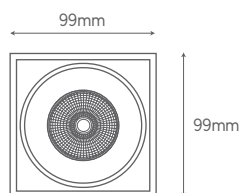
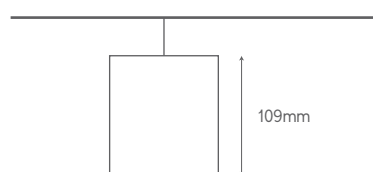

WATTAGE	CODE	CCT	BEAM ANGLE	EFFICACY (lm/W)	P. F.
10W	LDN 7310	3000K/4000K/6000K	50°	80/85/90	≥0.95



Application Areas

- Offices
- Home
- Showrooms
- Banks
- Café & Restaurants
- Hospitals
- School / Institutes

Standard Colors



Nora-D

Surface mount twin adjustable COB downlight with high efficient COB and reflector for better light distribution suitable for retail, hospitality and residential application area.

Features



Die-Cast
Aluminium & CRCA Body



High Efficient
COB

Surface

Product Dimensions

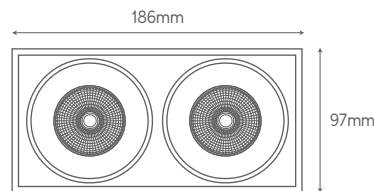

WATTAGE	CODE	CCT	BEAM ANGLE	EFFICACY (lm/W)	P. F.
2x10W	LDN 7220	3000K/4000K/6000K	50°	80/85/90	≥0.95

Suspended

Product Dimensions

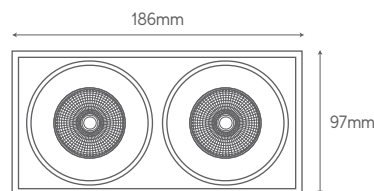
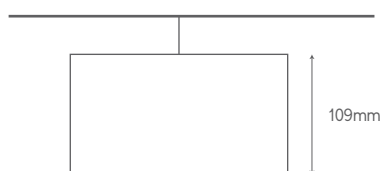

WATTAGE	CODE	CCT	BEAM ANGLE	EFFICACY (lm/W)	P. F.
2x10W	LDN 7420	3000K/4000K/6000K	50°	80/85/90	≥0.95





ACOUSTIC RANGE

A self textured fabric acoustic covered the LED luminaire, which gives a unique definition to the modern lighting. It creates a perfect environmental ambience by combining acoustic control and comfortable lighting that fits perfectly into living and working spaces. As this is available in multiple color options, you can adapt it as per your surrounding ambience.

This luminaire provides efficient LED Light with maximum lighting comfort . And the acoustic absorption of sound gives an extra benefit to its design. The material is specially chosen for its sound absorbing characteristics. The unique shape of the acoustic not only has sound absorption feature but also partially screens the direct view of the central emitting surface.

ACOUSTIC RANGE

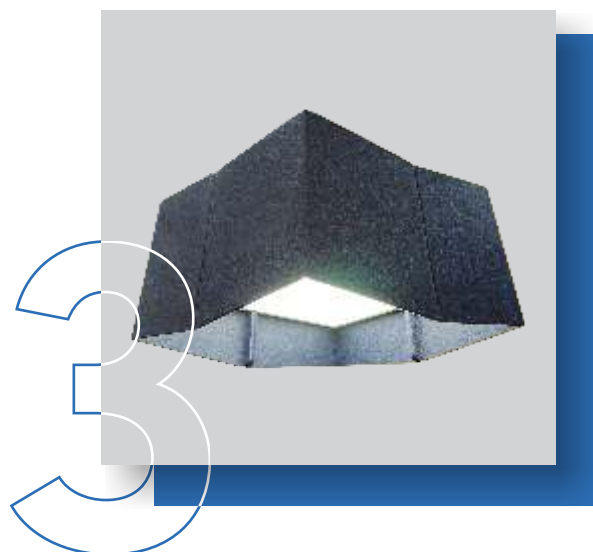
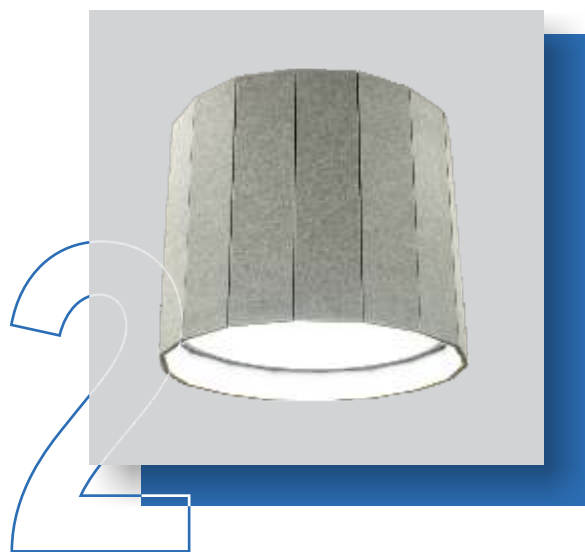

ACOUSTIC RANGE

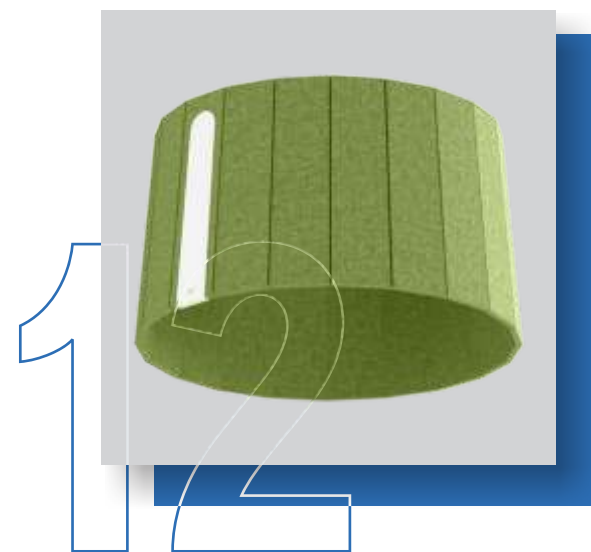
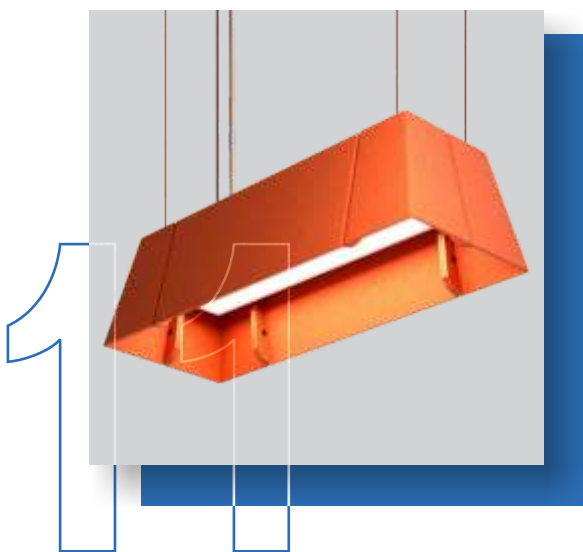
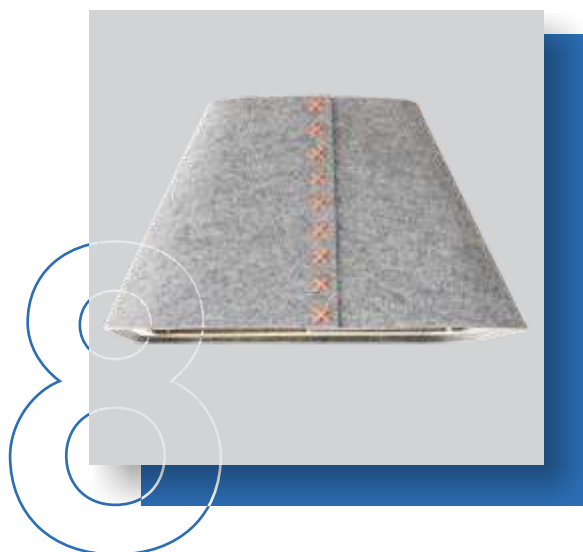
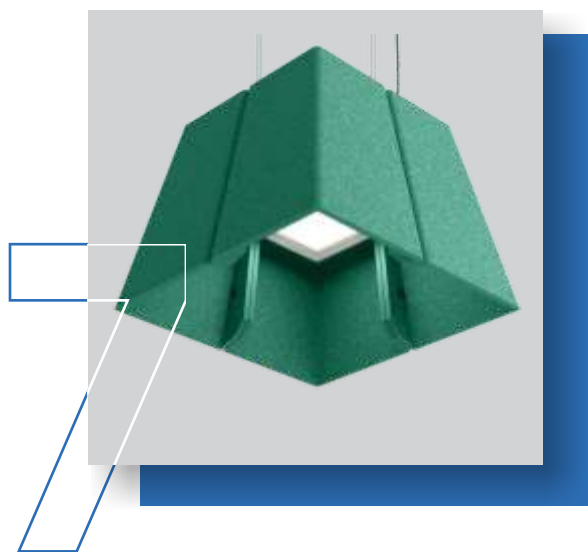



TRACK LUMINAIRES

The magnetic track channel for a track light comes in multiple forms like recessed, suspended or surface mounted. It supports multiple ranges of spots and can be easily accessed from anywhere on the track due to its outstanding magnetic structure. Track lights assure a very compact design and performance is their strongest asset.

This Magnetic Track Range made up of high quality aluminium which is perfect for office, home, and any other space with hustle-free luminaire installation.

MAGNETIC TRACK LUMINAIRES

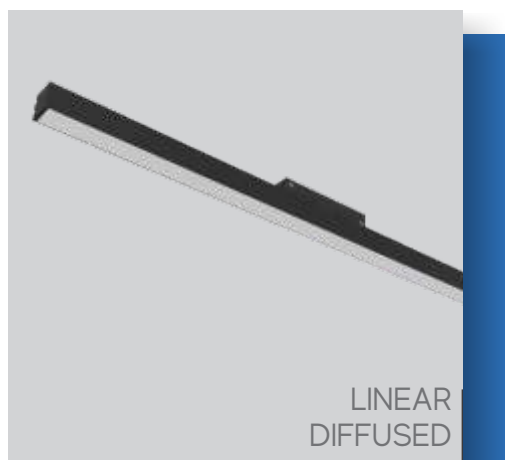

Wattage	LENGTH
12W	300 mm
24W	600 mm



Wattage	LENGTH
24W	300 mm X 300 mm



Wattage	LENGTH
6W	113mm
12W	220mm
18W	328mm
24W	435mm



Wattage	LENGTH
6W	120mm
12W	228mm
18W	334mm



Wattage	LENGTH
12W	D-50,H-180
24W	D-60,H-200

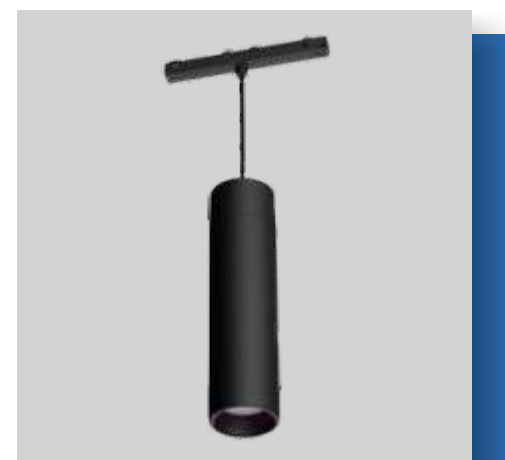

Wattage	LENGTH
12W	D-55

MAGNETIC TRACK ACCESSORIES



Wattage
100W / 200W



MAGNETIC TRACK ACCESSORIES

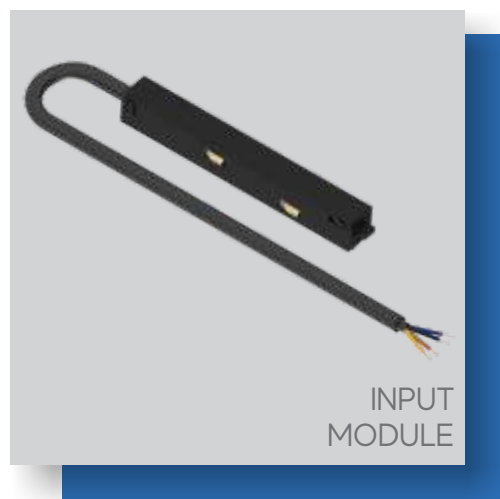

Ace

Ace track light Organic design with die cast housing & heat sink for efficient heat dissipation. Optical lens with 24° and 36° beam angle for better light distribution. Optical and thermal solution for high performance.

Features



Unique Lens to cut glare



Die-Cast Aluminium Housing

Product Dimensions

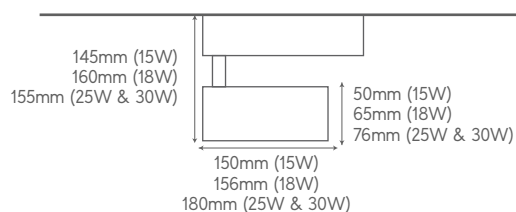

WATTAGE	CODE	CCT	BEAM ANGLE	White Finish	Black & Grey Finish	P. F.
				EFFICACY (lm/W(±5%))	EFFICACY (lm/W(±5%))	
15W	LAC 1015	3000K/4000K/6000K	24° & 36°	80/85/90	75/80/85	≥0.95
18W	LAC 1018	3000K/4000K/6000K	24° & 36°	90/95/100	85/90/95	≥0.95
25W	LAC 1025	3000K/4000K/6000K	24° & 36°	90/95/100	85/90/95	≥0.95
30W	LAC 1030	3000K/4000K/6000K	24° & 36°	80/85/90	75/80/85	≥0.95



Application Areas

- Offices
- Home
- Showrooms
- Banks
- Café & Restaurants
- Hospitals
- School / Institutes

Standard Colors



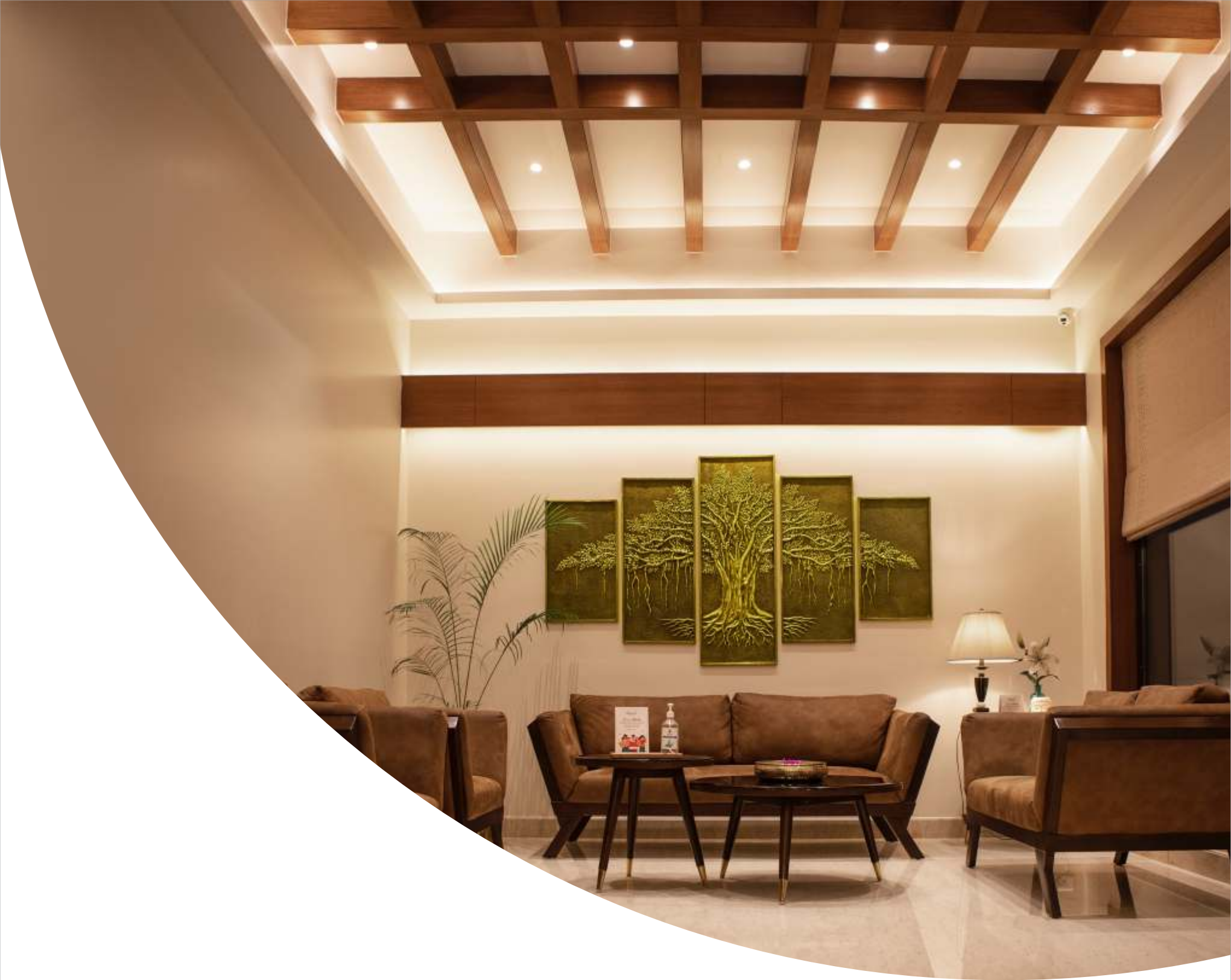

Aries

Indoor Range

Indoor Lighting is an often underestimated part of our homes and businesses. Besides having a huge impact on aesthetics and functionality, it can also have profound effects on your mood, emotions, and well being. With our R & D team, we emphasize a more human-centric lighting concept that can be served through our sundry products.

We focus to match your taste of lighting concepts whether it's one-layer or two-layer lighting. this is how lighting design can be minimized while still obtaining the perfect atmosphere in any given room.



SPOTS

Lego

Recessed COB downlight made up of die-cast aluminium housing & robust heat sink for excellent thermal management, also it offers a wide choice of option for different color reflectors (Rose Gold, Gold, Silver, Gun Metal, White & Black).

Features



High Efficient
COB



Die-Cast
Aluminium Body

Product Dimensions

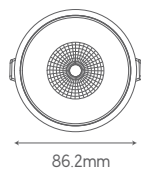
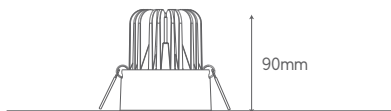

Cutout (ø)
80mm



WATTAGE	CODE	CCT	BEAM ANGLE	EFFICACY (lm/W)	P. F.
8W	LRS 8908	3000K/4000K/6000K	15°/24°/36°/50°/60°	75/80/85	≥0.95
12W	LRS 8912	3000K/4000K/6000K	15°/24°/36°/50°/60°	75/80/85	≥0.95
14W	LRS 8914	3000K/4000K/6000K	15°/24°/36°/50°/60°	75/80/85	≥0.95



Application Areas

- Offices
- Home
- Showrooms
- Banks
- Café & Restaurants
- Hospitals
- School / Institutes

Standard Colors



Sol

Recessed COB down light made of die cast aluminum housing and robust heat sink for excellent thermal management. It consists of high efficiency polycarbonate reflector to produce excellent light output.

Features



High Efficient
COB



Die-Cast
Aluminium Body

Product Dimensions

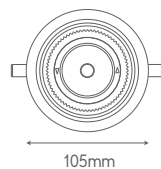
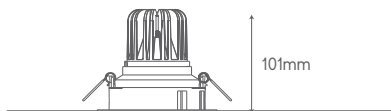

Cutout (ø)
94mm

WATTAGE	CODE	CCT	BEAM ANGLE	EFFICACY (lm/W)	P. F.
8W	LHR 5608	3000K/4000K/6000K	15°/24°/36°/50°/60°	70/75/80	≥0.95
12W	LHR 5612	3000K/4000K/6000K	15°/24°/36°/50°/60°	70/75/80	≥0.95
14W	LHR 5614	3000K/4000K/6000K	15°/24°/36°/50°/60°	70/75/80	≥0.95



Application Areas

- Offices
- Home
- Showrooms
- Banks
- Café & Restaurants
- Hospitals
- School / Institutes

Standard Colors



DALI

1-10V

Wifi

RF

HCL

Ta(°C)
-10/+40

F₁<5%

50/60
Hz

CRI
>80

CT

Nova

Decorative deep COB spot downlight with designer trim and deep recessed reflector to cut glare.

Features



High Efficient
COB



Die-Cast
Aluminium Body

Product Dimensions

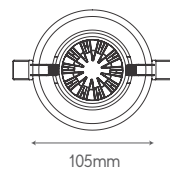
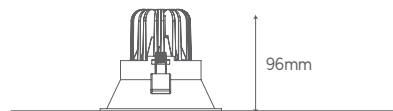

Cutout (ø)
93mm

WATTAGE	CODE	CCT	BEAM ANGLE	EFFICACY (lm/W)	P. F.
8W	LRS 5108	3000K/4000K/6000K	15°/24°/36°/50°/60°	75/80/85	≥0.95
12W	LRS 5112	3000K/4000K/6000K	15°/24°/36°/50°/60°	80/85/90	≥0.95
14W	LRS 5114	3000K/4000K/6000K	15°/24°/36°/50°/60°	75/80/85	≥0.95



Application Areas

- Offices
- Home
- Showrooms
- Banks
- Café & Restaurants
- Hospitals
- School / Institutes

Standard Colors



DALI

1-10V

Wifi

RF

HCL

Ta(°C)
-10/+40

F₁<5%

50/60
Hz

CRI
>80

CT

Docco

Compact styling, clean fascias and enclosed precision die-cast adjustable lamp housing with polycarbonate reflector & energy efficient light sources .

Features



High Efficient
COB

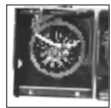

Die-Cast
Aluminium Body

Product Dimensions

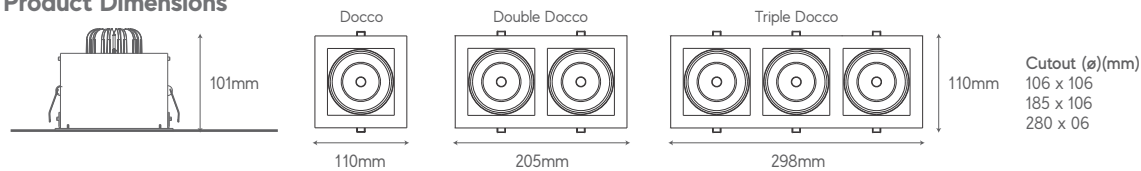

	WATTAGE	CODE	CCT	BEAM ANGLE	EFFICACY (lm/W)	P. F.
Docco	8W	LHR 6108	3000K/4000K/6000K	15°/24°/36°/50°/60°	80/85/90	≥0.98
	12W	LHR 6112	3000K/4000K/6000K	15°/24°/36°/50°/60°	80/85/90	≥0.95
	14W	LHR 6114	3000K/4000K/6000K	15°/24°/36°/50°/60°	75/80/85	≥0.95
Double Docco	16W	LHR 6216	3000K/4000K/6000K	15°/24°/36°/50°/60°	80/85/90	≥0.98
	24W	LHR 6224	3000K/4000K/6000K	15°/24°/36°/50°/60°	80/85/90	≥0.95
	28W	LHR 6228	3000K/4000K/6000K	15°/24°/36°/50°/60°	75/80/85	≥0.95
Triple Docco	24W	LHR 6324	3000K/4000K/6000K	15°/24°/36°/50°/60°	80/85/90	≥0.98
	36W	LHR 6336	3000K/4000K/6000K	15°/24°/36°/50°/60°	80/85/90	≥0.95
	42W	LHR 6342	3000K/4000K/6000K	15°/24°/36°/50°/60°	75/80/85	≥0.95



Application Areas

- Offices
- Home
- Showrooms
- Banks
- Café & Restaurants
- Hospitals
- School / Institutes

Standard Colors



DALI

1-10V

RAL

HCL



50/60
Hz



Mika

High efficient square COB recess downlight encompassing of die-cast aluminium trim and deep recess reflector to cut glare & Suitable for multiple applications. Best optical and thermal solution for high performance.

Features



High Efficient
COB



Die-Cast
Aluminium Body

Product Dimensions

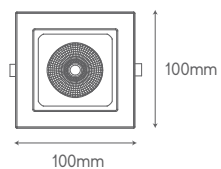
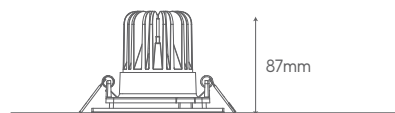

Cutout (ø) (mm)
79 x 94

WATTAGE	CODE	CCT	BEAM ANGLE	EFFICACY (lm/W)	P. F.
8W	LRS 9008	3000K/4000K/6000K	15°/24°/36°/50°/60°	75/80/85	≥0.98
12W	LRS 9012	3000K/4000K/6000K	15°/24°/36°/50°/60°	75/80/85	≥0.95
14W	LRS 9014	3000K/4000K/6000K	15°/24°/36°/50°/60°	75/80/85	≥0.95



Application Areas

- Offices
- Home
- Showrooms
- Banks
- Café & Restaurants
- Hospitals
- School / Institutes

Standard Colors



DALI

1-10V

Wifi

RF

HCL



F_l<5%

50/60
Hz



CT

Vela

The COB wallwasher with softly contoured polycarbonate reflector & energy efficient light source that combines to produce luminaire of exceptional performance.

Features



High Efficient
COB



Die-Cast
Aluminium Body

Product Dimensions

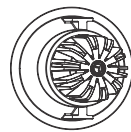
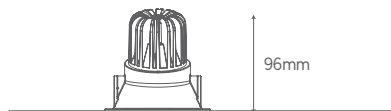

Cutout (ø)
88mm

96mm



WATTAGE	CODE	CCT	BEAM ANGLE	EFFICACY (lm/W)	P. F.
8W	LHR 6508	3000K/4000K/6000K	15°/24°/36°/50°/60°	75/80/85	≥0.98
12W	LHR 6512	3000K/4000K/6000K	15°/24°/36°/50°/60°	75/80/85	≥0.95
14W	LHR 6514	3000K/4000K/6000K	15°/24°/36°/50°/60°	75/80/85	≥0.95



Application Areas

- Offices
- Home
- Showrooms
- Banks
- Café & Restaurants
- Hospitals
- School / Institutes

Standard Colors



DALI

1-10V

Wifi

RF

HCL

Ta(°C)
-10/+40

F_l<5%

50/60
Hz

CRI
>80

CT

Opal

Recess adjustable COB downlight made of die-cast aluminium housing and robust heat sink for excellent thermal management. It consists of high efficiency reflector to produce excellent light output.

Features



High Efficient
COB



Die-Cast
Aluminium Body

Product Dimensions

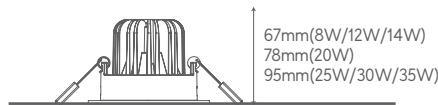

67mm(8W/12W/14W)
78mm(20W)
95mm(25W/30W/35W)

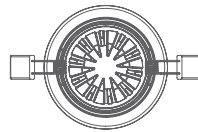

88mm(8W/12W/14W)
120mm(20W)
159mm(25W/30W/35W)

Cutout (ø)
75mm(8W/12W/14W)
106mm(20W)
140mm(25W/30W/35W)



WATTAGE	CODE	CCT	BEAM ANGLE	EFFICACY (lm/W)	P. F.
8W	LRS 6008	3000K/4000K/6000K	15°/24°/36°/50°/60°	80/85/90	≥0.98
12W	LRS 6012	3000K/4000K/6000K	15°/24°/36°/50°/60°	85/90/95	≥0.95
14W	LRS 6014	3000K/4000K/6000K	15°/24°/36°/50°/60°	80/85/90	≥0.95
20W	LRS 6020	3000K/4000K/6000K	40°	80/85/90	≥0.95
25W	LRS 6025	3000K/4000K/6000K	50°	80/85/90	≥0.95
30W	LRS 6030	3000K/4000K/6000K	50°	80/85/90	≥0.95
35W	LRS 6035	3000K/4000K/6000K	50°	80/85/90	≥0.95



Application Areas

- Offices
- Home
- Showrooms
- Banks
- Café & Restaurants
- Hospitals
- School / Institutes

Standard Colors



Avio

The COB spot light with softly contoured reflector and energy efficient light source that combines to produce a luminaire of exceptional style and performance.

Features



High Efficient
COB



Die-Cast
Aluminium Body

Product Dimensions

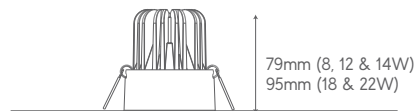

79mm (8, 12 & 14W)
95mm (18 & 22W)

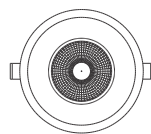

82mm (8, 12 & 14W)
125mm (18 & 22W)

Cutout (ø)
70mm (8, 12 & 14W)
117mm (18 & 22W)

WATTAGE	CODE	CCT	BEAM ANGLE	EFFICACY (lm/W)	P. F.
8W	LRS 7008	3000K/4000K/6000K	15°/24°/36°/50°/60°	75/80/85	≥0.98
12W	LRS 7012	3000K/4000K/6000K	15°/24°/36°/50°/60°	75/80/85	≥0.95
14W	LRS 7014	3000K/4000K/6000K	15°/24°/36°/50°/60°	75/80/85	≥0.95
18W	LRS 7018	3000K/4000K/6000K	40°	70/75/80	≥0.95
22W	LRS 7022	3000K/4000K/6000K	40°	70/75/80	≥0.95



Application Areas

- Offices
- Home
- Showrooms
- Banks
- Café & Restaurants
- Hospitals
- School / Institutes

Standard Colors



DALI

1-10V



F_l<5%

50/60
Hz

CRI
>80

Omega-R

Recessed COB downlights made of high efficiency die-cast aluminium with powder coated finish. Available with comprehensive choice of color temperatures and wattages.

Features



High Efficient
COB



Die-Cast
Aluminium Body

Product Dimensions



WATTAGE	CODE	CCT	BEAM ANGLE	EFFICACY (lm/W)	P. F.
20W	LHR 6720	3000K/4000K/6000K	50°	75/80/85	≥0.95
25W	LHR 6725	3000K/4000K/6000K	50°	75/80/85	≥0.95
30W	LHR 6730	3000K/4000K/6000K	50°	75/80/85	≥0.95



Application Areas

- Offices
- Home
- Showrooms
- Banks
- Café & Restaurants
- Hospitals
- School / Institutes

Standard Colors



DALI

1-10V



Ta(°C)
-10/+40

F<5%

50/60
Hz

CRI
>80

Sigma

The design features include fully enclosed precision die-cast aluminium construction, excellent pan and tilt adjustment. These adjustable recessed single chip COB downlights consist of high purity aluminium reflector.

Features

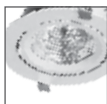

30°Tilt Option



Die-Cast
Aluminium Body

Product Dimensions

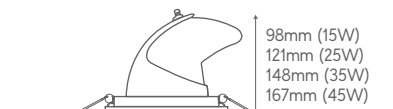

98mm (15W)
121mm (25W)
148mm (35W)
167mm (45W)

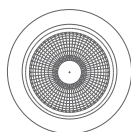

114mm (15W)
137mm (25W)
163.5mm (35W)
190.5mm (45W)

Cutout (ø)
102mm (15W)
129mm (25W)
154mm (35W)
174mm (45W)

WATTAGE	CODE	CCT	BEAM ANGLE	EFFICACY (lm/W)	P. F.
15W	LHR 6815	3000K/4000K/6000K	24°	80/85/90	≥0.95
25W	LHR 6825	3000K/4000K/6000K	35°	80/85/90	≥0.95
35W	LHR 6835	3000K/4000K/6000K	40°	85/90/95	≥0.95
45W	LHR 6845	3000K/4000K/6000K	40°	80/85/90	≥0.95



Application Areas

- Offices
- Home
- Showrooms
- Banks
- Café & Restaurants
- Hospitals
- School / Institutes

Standard Colors





MINI SPOTS

Gia

Small Recessed COB Round downlight made of die-cast aluminium with powder coating finish. Excellent heat sink capacity to minimize luminous degradation.

Features



High Efficient
COB



Die-Cast
Aluminium Body

Product Dimensions

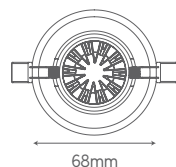
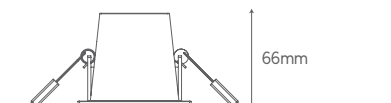

Cutout (ø)
61mm



WATTAGE	CODE	CCT	BEAM ANGLE	EFFICACY (lm/W)	P. F.
7W	LRS 8007 (Black Reflector)	3000K/4000K/6000K	36°	65/70/75	≥0.95
7W	LRS 8007 (White Reflector)	3000K/4000K/6000K	36°	65/70/75	≥0.95
7W	LRS 8007 (Copper Reflector)	3000K/4000K/6000K	36°	65/70/75	≥0.95
7W	LRS 8007(Silver Anodized Reflector)	3000K/4000K/6000K	36°	65/70/75	≥0.95



Application Areas

- Offices
- Home
- Showrooms
- Banks
- Café & Restaurants
- Hospitals
- School / Institutes

Standard Colors



Mia

Small Recessed COB square downlight made of die-cast aluminium with powder coating finish. Excellent heat sink capacity to minimize luminous degradation.

Features



High Efficient
COB



Die-Cast
Aluminium Body

Product Dimensions

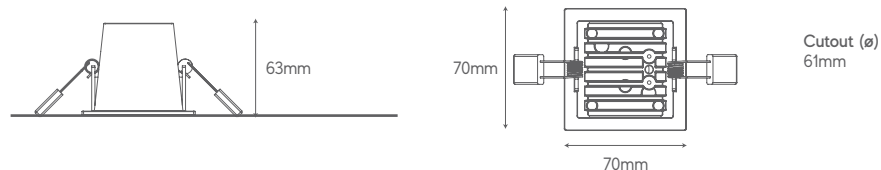

WATTAGE	CODE	CCT	BEAM ANGLE	EFFICACY (lm/W)	P. F.
7W	LRS 8107 (Black Reflector)	3000K/4000K/6000K	36°	65/70/75	≥0.95
7W	LRS 8107 (White Reflector)	3000K/4000K/6000K	36°	65/70/75	≥0.95
7W	LRS 8107 (Copper Reflector)	3000K/4000K/6000K	36°	65/70/75	≥0.95
7W	LRS 8107 (Silver Anodized Reflector)	3000K/4000K/6000K	36°	65/70/75	≥0.95



Application Areas

- Offices
- Home
- Showrooms
- Banks
- Café & Restaurants
- Hospitals
- School / Institutes

Standard Colors



Cribo

Small adjustable recessed downlight with die-cast aluminium body & reflector with 15 degree tilt option, excellent heat sink capability to minimize luminous degradation.

Features



High Efficient
COB



Die-Cast
Aluminium Body

Product Dimensions

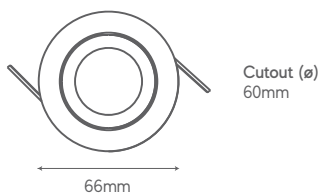

WATTAGE	CODE	CCT	BEAM ANGLE	EFFICACY (lm/W)	P. F.
5W	LRS 1205	3000K/4000K/6000K	40°	70/75/80	≥0.95



Application Areas

- Offices
- Home
- Showrooms
- Banks
- Café & Restaurants
- Hospitals
- School / Institutes

Standard Colors



Ziva

Recessed small COB downlight in circular shape made of die-cast aluminium housing and has robust heat sink for excellent thermal management. It consist of high efficiency reflector to produce excellent light output.

Features



High Efficient
COB



Die-Cast
Aluminium Body

Product Dimensions

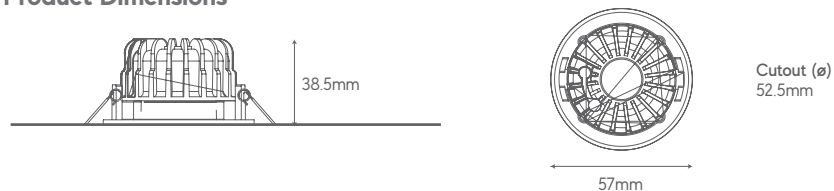

WATTAGE	CODE	CCT	BEAM ANGLE	EFFICACY (lm/W)	P. F.
5W	LRS 1305	3000K/4000K/6000K	40°	80/85/90	≥0.95



Application Areas

- Offices
- Home
- Showrooms
- Banks
- Café & Restaurants
- Hospitals
- School / Institutes

Standard Colors



Button

The spotlight combines a sharp design with energy efficient LED module. The high quality lens further enhances the quality of the product which is housed within a die-cast aluminium body.

Features



High Efficient
COB



Die-Cast
Aluminium Body

Product Dimensions



WATTAGE	CODE	CCT	BEAM ANGLE	EFFICACY (lm/W)	P. F.
2W	LRS 1002	3000K/6000K	20°	50/55	≥0.32



Application Areas

- Offices
- Home
- Showrooms
- Banks
- Café & Restaurants
- Hospitals
- School / Institutes

Standard Colors



Ta(°C)
-10/+40

50/60
Hz

CRI
>80

Cell

The spotlight combines a sharp design with energy efficient COB module. It consists of high efficiency chrome plated PC reflector to produce excellent light output which is housed within a die-cast aluminium body.

Features



High Efficient
COB



Die-Cast
Aluminium Body

Product Dimensions

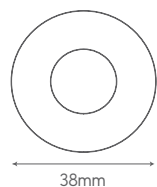

Cutout (ø)
28mm

WATTAGE	CODE	CCT	BEAM ANGLE	EFFICACY (lm/W)	P. F.
3W	LRS 1403	3000K/4000K/6000K	65°	65/70/75	≥0.4



Application Areas

- Offices
- Home
- Showrooms
- Banks
- Café & Restaurants
- Hospitals
- School / Institutes

Standard Colors





Commercial Downlighters

NEW

Drop

The LED downlight with 100 lm/w. Made of Die-cast aluminium. Drop-down diffuser follow the LG7 Guidelines and illuminates the ceiling, walls, floor & task area.

Features



Drop-Down Diffuser



Die-Cast Aluminium Housing

Product Dimensions

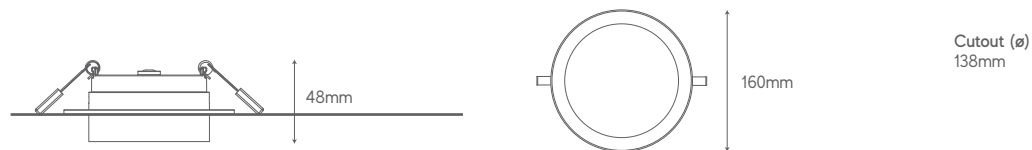

WATTAGE	CODE	CCT	BEAM ANGLE	EFFICACY (lm/W)	P. F.
15W	PDD 1015	3000K/4000K/6000K	120°	90/95/100	≥0.95
18W	PDD 1018	3000K/4000K/6000K	120°	90/95/100	≥0.95



Application Areas

- Offices
- Home
- Showrooms
- Banks
- Café & Restaurants
- Hospitals
- School / Institutes

Standard Colors



DALI

1-10V

Ta(°C)
-10/+40

F_l<5%

50/60
Hz

OP
DIFFUSER

CRI
>80

TRAIC

NEW

Dart

Dart round backlit LED downlight made up of die-cast housing & light weight plastic trim which is designed as a reflector to give high lumen efficacy. Also opal diffuser is fixed in inner periphery of deep recessed trim to cut down the glare & provide uniform light output With efficacy 95-100lm/W.

Features



Deep-Down
Diffuser



Die-Cast
Aluminium Housing

Product Dimensions

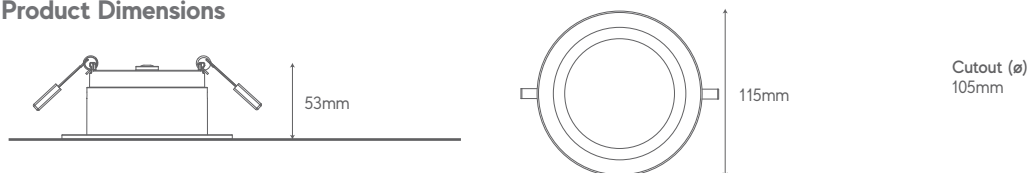

WATTAGE	CODE	CCT	BEAM ANGLE	EFFICACY (lm/W)	P. F.
9W	RDD 1009	3000K/4000K/6000K	90°	90/95/100	≥0.95
13W	RDD 1013	3000K/4000K/6000K	90°	90/95/100	≥0.95



Application Areas

- Offices
- Home
- Showrooms
- Banks
- Café & Restaurants
- Hospitals
- School / Institutes

Standard Colors



Oculus

Sleek round backlit LED downlight made up of die-cast housing with ring shape diffuser to give decorative & unique look to the product.

Features



Die-Cast
Aluminium Body



High Efficient
Diffuser

Product Dimensions

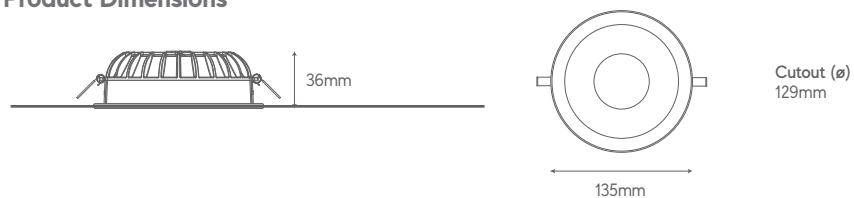

WATTAGE	CODE	CCT	BEAM ANGLE	EFFICACY (lm/W)	P. F.
15W	LOC 015	3000K/4000K/6000K	105°	80/85/90	≥0.95
18W	LOC 018	3000K/4000K/6000K	105°	80/85/90	≥0.95
20W	LOC 020	3000K/4000K/6000K	105°	80/85/90	≥0.95



Application Areas

- Offices
- Home
- Showrooms
- Banks
- Café & Restaurants
- Hospitals
- School / Institutes

Standard Colors



DALI

1-10V



F_l<5%



Omega

A versatile collection of energy efficient round LED downlight for general lighting in various applications. These recessed diffused round LED downlights are made of high efficient die-cast aluminium housing with high transmission factor diffuser.

Features



Die-Cast
Aluminium Body



High Efficient
Diffuser

Product Dimensions

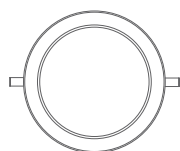
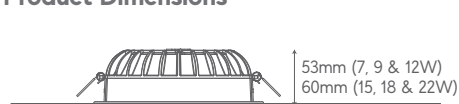

112mm (7W)
145mm (9 & 12W)
175mm (15, 18 & 22W)

Cutout (∅)
102mm (7W)
134mm (9 & 12W)
164mm (15, 18 & 22W)

WATTAGE	CODE	CCT	BEAM ANGLE	EFFICACY (lm/W)	P. F.
7W	LVT 6507	3000K/4000K/6000K	110°	60/65/70	≥0.95
9W	LVT 6509	3000K/4000K/6000K	100°	75/80/85	≥0.95
12W	LVT 6512	3000K/4000K/6000K	100°	90/95/100	≥0.95
15W	LVT 6515	3000K/4000K/6000K	110°	75/80/85	≥0.95
18W	LVT 6518	3000K/4000K/6000K	110°	75/80/85	≥0.95
22W	LVT 6522	3000K/4000K/6000K	110°	70/75/80	≥0.95



Application Areas

- Offices
- Home
- Showrooms
- Banks
- Café & Restaurants
- Hospitals
- School / Institutes

Standard Colors



DALI

1-10V



F₁<5%



Omega-R

Surface mount COB downlight with high efficient COB & reflector for better light distribution. Housing made of CRCA.

Features



High Efficient
COB



Die-Cast
Aluminium Body

Surface

Product Dimensions

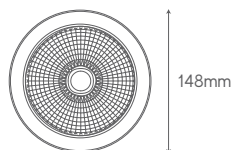
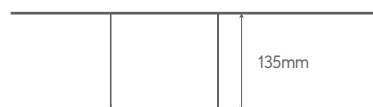

WATTAGE	CODE	CCT	BEAM ANGLE	EFFICACY (lm/W)	P. F.
20W	LVS R 6520	3000K/4000K/6000K	50°	75/80/85	≥0.95

Suspended

Product Dimensions

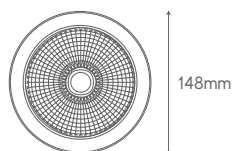

WATTAGE	CODE	CCT	BEAM ANGLE	EFFICACY (lm/W)	P. F.
20W	LVS R 6820	3000K/4000K/6000K	50°	75/80/85	≥0.95



Application Areas

- Offices
- Home
- Showrooms
- Banks
- Café & Restaurants
- Hospitals
- School / Institutes

Standard Colors



Omega-D

Compact styling, clean fascias and enclosed precision die-cast adjustable lamp housing with polycarbonate diffuser & energy efficient light sources.

Features



Die-Cast
Aluminium Body



High Efficient
Diffuser

Product Dimensions



WATTAGE	CODE	CCT	BEAM ANGLE	EFFICACY (lm/W)	P. F.
20W	LHR 6920	3000K/4000K/6000K	100°	75/80/85	≥0.95
25W	LHR 6925	3000K/4000K/6000K	100°	75/80/85	≥0.95
30W	LHR 6930	3000K/4000K/6000K	100°	75/80/85	≥0.95



Application Areas

- Offices
- Home
- Showrooms
- Banks
- Café & Restaurants
- Hospitals
- School / Institutes

Standard Colors



DALI

1-10V



Ta(°C)
-10/+40

F_l<5%



50/60
Hz



OP
DIFFUSER



CRI
>80



TRAIC

NEW

Atmos Pro

Sleek round backlit LED downlight made up of die-cast housing & light weight plastic trim which is designed as a reflector to give high lumen efficacy. Also opal / prismatic diffuser is fixed in inner periphery of trim to cut down the glare & provide uniform light output.

Features



Die-Cast Aluminium



High Efficient Diffuser



Also Available in Prismatic Diffuser

Product Dimensions

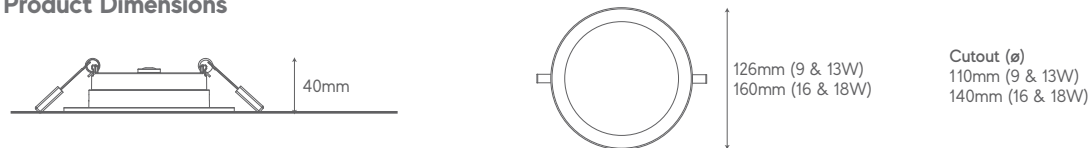

WATTAGE	CODE	CCT	BEAM ANGLE	EFFICACY (lm/W)	P. F.
10W	LATP 009	3000K/4000K/6000K	100°	95/100/105	≥0.95
13W	LATP 013	3000K/4000K/6000K	100°	95/100/105	≥0.95
16W	LATP 016	3000K/4000K/6000K	100°	100/105/110	≥0.95
18W	LATP 018	3000K/4000K/6000K	100°	100/105/110	≥0.95
10W	LATP 009PR	3000K/4000K/6000K	85°	90/95/100	≥0.95
13W	LATP 013PR	3000K/4000K/6000K	85°	90/95/100	≥0.95
16W	LATP 016PR	3000K/4000K/6000K	85°	95/100/105	≥0.95
18W	LATP 018PR	3000K/4000K/6000K	85°	95/100/105	≥0.95

WATTAGE	CODE	CCT	BEAM ANGLE	EFFICACY (lm/W)	P. F.
10W	LAT 009	3000K/4000K/6000K	100°	80/85/90	≥0.95
13W	LAT 013	3000K/4000K/6000K	100°	80/85/90	≥0.95
16W	LAT 016	3000K/4000K/6000K	100°	80/85/90	≥0.95
18W	LAT 018	3000K/4000K/6000K	100°	80/85/90	≥0.95
10W	LAT 009PR	3000K/4000K/6000K	85°	75/80/85	≥0.95
13W	LAT 013PR	3000K/4000K/6000K	85°	75/80/85	≥0.95
16W	LAT 016PR	3000K/4000K/6000K	85°	75/80/85	≥0.95
18W	LAT 018PR	3000K/4000K/6000K	85°	70/75/80	≥0.95



Application Areas

- Offices
- Home
- Showrooms
- Banks
- Café & Restaurants
- Hospitals
- School / Institutes

Standard Colors



DALI

1-10V

Wifi

RF

HCL

Ta(°C)
-10/+40

F1<5%

50/60
Hz

OP
DIFFUSER

PR
DIFFUSER

CRI
>80

CRI
>90

CT

NEW

Atmos Surface

Atmos Surface mount deep recessed LED downlight made up of Die-cast aluminium & Sheet metal housing. Specular finished diffuser with high efficient LEDs for better light distribution.

Features



Die-Cast
Aluminium Body



High Efficient
Diffuser

Product Dimensions

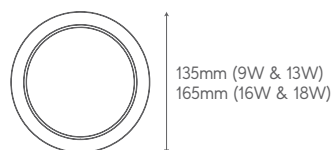

WATTAGE	CODE	CCT	BEAM ANGLE	EFFICACY (lm/W)	P. F.
9W	LAT-S 009	3000K/4000K/6000K	100°	80/85/90	≥0.95
13W	LAT-S 013	3000K/4000K/6000K	100°	80/85/90	≥0.95
16W	LAT-S 016	3000K/4000K/6000K	100°	80/85/90	≥0.95
18W	LAT-S 018	3000K/4000K/6000K	100°	80/85/90	≥0.95

Application Areas

- Offices
- Home
- Showrooms
- Banks
- Café & Restaurants
- Hospitals
- School / Institutes

Standard Colors



Ta(°C)
-10/+40

OP
DIFFUSER

50/60
Hz

CRI
>80

NEW

Pearl Pro (R)

Sleek round backlit LED downlight made up of die-cast housing & light weight plastic trim designed for better aesthetics with high efficacy LEDs and diffuser to give glare free output.

Features

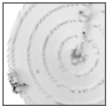

Die-Cast Aluminium Body



High Efficient LED

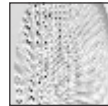

Also Available in Prismatic Diffuser

Product Dimensions

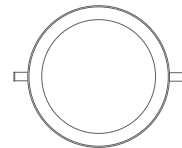

108mm (5W)
130mm (12W)
160mm (15 & 18W)

Cutout (ø)
79mm (5W)
105mm (12W)
138mm (15 & 18W)



Pro
Opal Diffuser

WATTAGE	CODE	CCT	BEAM ANGLE	EFFICACY (lm/W)	P. F.
5W	LRSP 2005	3000K/4000K/6000K	100°	95/100/105	≥0.95
12W	LRSP 2012	3000K/4000K/6000K	110°	100/105/110	≥0.95
15W	LRSP 2015	3000K/4000K/6000K	110°	105/110/115	≥0.95
18W	LRSP 2018	3000K/4000K/6000K	110°	105/110/115	≥0.95

Pro
Prismatic Diffuser

5W	LRSP 2005PR	3000K/4000K/6000K	85°	90/95/100	≥0.95
12W	LRSP 2012PR	3000K/4000K/6000K	85°	95/100/105	≥0.95
15W	LRSP 2015PR	3000K/4000K/6000K	85°	100/105/110	≥0.95
18W	LRSP 2018PR	3000K/4000K/6000K	85°	100/105/110	≥0.95

Standard
Opal Diffuser

WATTAGE	CODE	CCT	BEAM ANGLE	EFFICACY (lm/W)	P. F.
5W	LRS 2005	3000K/4000K/6000K	100°	70/75/80	≥0.95
12W	LRS 2012	3000K/4000K/6000K	110°	75/80/85	≥0.95
15W	LRS 2015	3000K/4000K/6000K	110°	80/85/90	≥0.95
18W	LRS 2018	3000K/4000K/6000K	110°	80/85/90	≥0.95

Standard
Prismatic Diffuser

5W	LRS 2005PR	3000K/4000K/6000K	85°	65/70/75	≥0.95
12W	LRS 2012PR	3000K/4000K/6000K	85°	70/75/80	≥0.95
15W	LRS 2015PR	3000K/4000K/6000K	85°	70/75/80	≥0.95
18W	LRS 2018PR	3000K/4000K/6000K	85°	70/75/80	≥0.95



Application Areas

- Offices
- Home
- Showrooms
- Banks
- Café & Restaurants
- Hospitals
- School / Institutes

Standard Colors



DALI

1-10V

Wifi

RF

HCL

Ta(°C)
-10/+40

F1<5%

50/60
Hz

OP
DIFFUSER

PR
DIFFUSER

CRI
>80

CRI
>90

CT

NEW

Pearl (R) Surface

Pearl Round Surface mount LED downlight made up of Die-cast aluminium & Sheet metal housing. Specular finished diffuser with high efficient LEDs for better light distribution.

Features

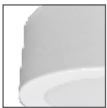

Die-Cast
Aluminium Body

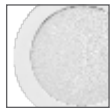

High Efficient
Diffuser

Product Dimensions

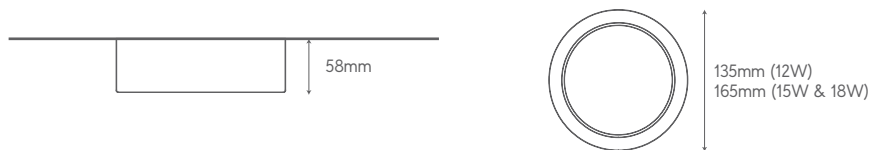

WATTAGE	CODE	CCT	BEAM ANGLE	EFFICACY (lm/W)	P. F.
12W	LRS-S 2012	3000K/4000K/6000K	110°	75/80/85	≥0.95
15W	LRS-S 2015	3000K/4000K/6000K	110°	80/85/90	≥0.95
18W	LRS-S 2018	3000K/4000K/6000K	110°	80/85/90	≥0.95

Application Areas

- Offices
- Home
- Showrooms
- Banks
- Café & Restaurants
- Hospitals
- School / Institutes

Standard Colors



Ta(°C)
-10/+40

OP
DIFFUSER

50/60
Hz

CRI
>80

Pearl (Sq)

Sleek round backlit LED downlight made up of die-cast housing & light weight plastic trim designed for better aesthetics with high efficacy LEDs and diffuser to give glare free output.

Features



Die-Cast
Aluminium Body



High Efficient
Diffuser



Also Available in
Prismatic Diffuser

Product Dimensions

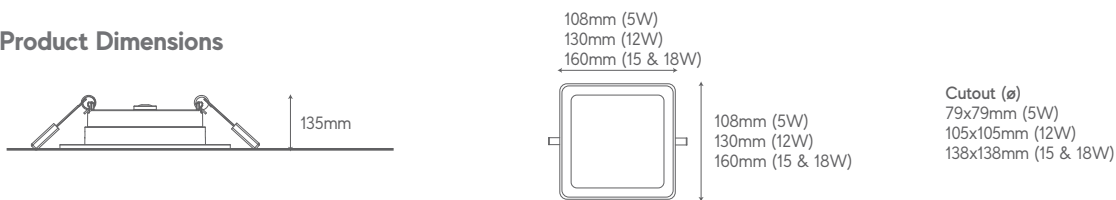

Opal Diffuser

WATTAGE	CODE	CCT	BEAM ANGLE	EFFICACY (lm/W)	P. F.
5W	LRS 3005	3000K/4000K/6000K	100°	70/75/80	≥0.95
12W	LRS 3012	3000K/4000K/6000K	110°	75/80/85	≥0.95
15W	LRS 3015	3000K/4000K/6000K	110°	80/85/90	≥0.95
18W	LRS 3018	3000K/4000K/6000K	110°	75/80/85	≥0.95

Prismatic Diffuser

5W	LRS 3005PR	3000K/4000K/6000K	85°	65/70/75	≥0.95
12W	LRS 3012PR	3000K/4000K/6000K	85°	75/80/85	≥0.95
15W	LRS 3015PR	3000K/4000K/6000K	85°	75/80/85	≥0.95
18W	LRS 3018PR	3000K/4000K/6000K	85°	75/80/85	≥0.95



Application Areas

- Offices
- Home
- Showrooms
- Banks
- Café & Restaurants
- Hospitals
- School / Institutes

Standard Colors



Coral (R)

Sleek round panel downlight with integrated edge-lit LEDs installed with highly efficient low glare diffuser for optimum light distribution. Housing is made of pressure die-cast aluminium.

Features



Die-Cast
Aluminium Body



High Efficient
Diffuser

Product Dimensions

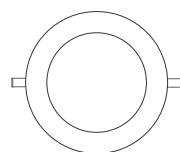

95mm (5W)
159mm (12 & 15W)
196mm (18 & 22W)

Cutout (ø)
80mm (5W)
142mm (12 & 15W)
176mm (18 & 22W)



WATTAGE	CODE	CCT	BEAM ANGLE	EFFICACY (lm/W)	P. F.
6W	LRS 4006	3000K/4000K/6000K	110°	45/50/55	≥0.95
12W	LRS 4012	3000K/4000K/6000K	110°	70/75/80	≥0.95
15W	LRS 4015	3000K/4000K/6000K	110°	65/70/75	≥0.95
18W	LRS 4018	3000K/4000K/6000K	110°	75/80/85	≥0.95
22W	LRS 4022	3000K/4000K/6000K	110°	70/75/80	≥0.95



Application Areas

- Offices
- Home
- Showrooms
- Banks
- Café & Restaurants
- Hospitals
- School / Institutes

Standard Colors



Coral Surface (R)

Surface mount round edge-lit downlight with high efficacy LEDs with highly efficient and low glare diffuser for optimum light distribution.

Features



High Efficient LEDs



Die-Cast Aluminium Body

Product Dimensions



WATTAGE	CODE	CCT	BEAM ANGLE	EFFICACY (lm/W)	P. F.
6W	LRS 3106	3000K/4000K/6000K	110°	45/50/55	≥0.95
12W	LRS 3112	3000K/4000K/6000K	110°	70/75/80	≥0.95
15W	LRS 3115	3000K/4000K/6000K	110°	65/70/75	≥0.95
18W	LRS 3118	3000K/4000K/6000K	110°	75/80/85	≥0.95
22W	LRS 3122	3000K/4000K/6000K	110°	75/80/85	≥0.95



Application Areas

- Offices
- Home
- Showrooms
- Banks
- Café & Restaurants
- Hospitals
- School / Institutes

Standard Colors



Coral (Sq)

Sleek square panel downlight with integrated edge-lit LEDs installed with highly efficient low glare diffuser for optimum light distribution. Housing is made of pressure die-cast aluminium.

Features



Die-Cast
Aluminium Body



High Efficient
Diffuser

Product Dimensions



100mm (5W)
140mm (12 & 15W)
190mm (18 & 22W)

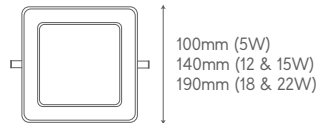

100mm (5W)
140mm (12 & 15W)
190mm (18 & 22W)

Cutout (ø)
83.5x83.5mm (5W)
119.5x119.5mm (12 & 15W)
176mm (18 & 22W)



WATTAGE	CODE	CCT	BEAM ANGLE	EFFICACY (lm/W)	P. F.
6W	LRS 5006	3000K/4000K/6000K	110°	45/50/55	≥0.95
12W	LRS 5012	3000K/4000K/6000K	110°	70/75/80	≥0.95
15W	LRS 5015	3000K/4000K/6000K	110°	65/70/75	≥0.95
18W	LRS 5018	3000K/4000K/6000K	110°	75/80/85	≥0.95
22W	LRS 5022	3000K/4000K/6000K	110°	70/75/80	≥0.95



Application Areas

- Offices
- Home
- Showrooms
- Banks
- Café & Restaurants
- Hospitals
- School / Institutes

Standard Colors



Coral Surface (Sq)

Surface mount square edge-lit downlight with high efficacy LEDs with highly efficient and low glare diffuser for optimum light distribution.

Features



Die-Cast
Aluminium Body



High Efficient
LEDs

Product Dimensions

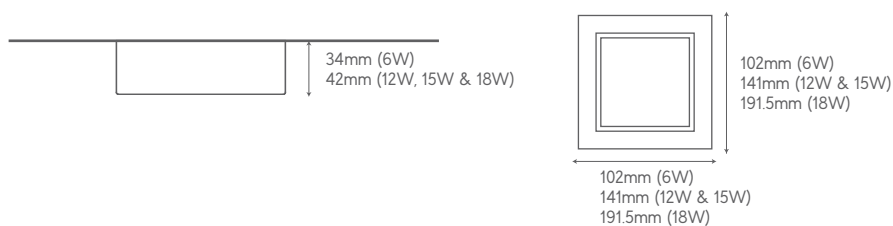

WATTAGE	CODE	CCT	BEAM ANGLE	EFFICACY (lm/W)	P. F.
6W	LRS 4106	3000K/4000K/6000K	110°	45/50/55	≥0.95
12W	LRS 4112	3000K/4000K/6000K	110°	70/75/80	≥0.97
15W	LRS 4115	3000K/4000K/6000K	110°	65/70/75	≥0.97
18W	LRS 4118	3000K/4000K/6000K	110°	75/80/85	≥0.95



Application Areas

- Offices
- Home
- Showrooms
- Banks
- Café & Restaurants
- Hospitals
- School / Institutes

Standard Colors



Recent Installation





Aditya Birla Group, Noida



Compu Com, Pune





OP Jindal University, Sonipat



PWD Project, Kolkata



JCI, Bangalore

Our Clients

DELHI INTERNATIONAL AIRPORT TERMINAL-3	KATHMANDU AIRPORT	STRYKER	TASKUS					
OP JINDAL UNIVERSITY	AHMEDABAD UNIVERSITY	INDIGO	MARRIOTT HOTEL	HONDA	COOPER			
PRAVIN MASALA	THYSSENKRUPP	INDIANA GRATINGS	PIAGGIO	ARISTOCRAT	DELOITTE			
HAWAS MEDIA	WILEY	PWC	IBBIBO	SCHNEIDER	AMAZON	ZOMATO	FREECHARGE	
COCA-COLA	AIRBNB	RENEW POWER	MAKEMYTRIP	REGUS	IIFL	PIRAMAL	PVR	
ERICSSON	QUICKHEAL	CANON	ADANI	VML	PAYTM	SODEXO	9A BUSINESS	HAWORTH
HP	BAE	AUTODESK	TCS	PEARL ACADEMY	SAMSUNG	TATA MOTORS	ADITYA BIRLA	
TATA SKY	SOMANY	KALPATARU	ACCENTURE	WESTERN UNION	LEGATO			
SABA SOFTWARE	E-ZEST	COX & KINGS	MAX	ATHENA	GLG	WINDSOR IT PARK	ERICSSON	
ITTPL	MANIPAL HOSPITAL	GROHE	DELHI GYMKHANA	EON IT PARK KHARADI	AZURE			
SAS	TIBCO	DECCAN GYMKHANA	EDIFECs	BIRLASOFT	LG CHEM	MARKIT	CLEO COUNTY	
VALUE PLUS	SIRION LAB	MOTT & MACDONALD	GODREJ	JAISPRING	IZENICA	DALMIA		
CLAIRVOLEX	AIRTEL	CUX CAPITAL	APCER	CLIFFORD	CINEPOLIS	APOLLO TYRES		
BAJAJ CAPITALS	BROWER STACK	CORNING	UPES BIDHOLI	SONY	KAS	INDIABULLS	CSGI	
LOHIA GROUP	BAJAJ	FREECHARGE	RAYMOND	BKT	PEARSON	DIVERSE LYNX		
JAIPURIA SCHOOL	VARSA PLASTIC IOC	HYUNDAI MOTOR	YES BANK	GOOGLE	SHAHI EXPORT			
RADHANIK EXPORT	YES BANK	BANK OF BAHRAIN	BANDHAN BANK	AMBUJA, KOLKATA	HUL			





The Lighting Specialist



LegeroLighting

Corporate Office

E-139, Sector 63, Noida - 201301, India
+91 120 4272775
info@legerolighting.com

Kolkata Office

GE-173, Rajdanga Main Road,
Near Kollolini Hotel, Kolkata-700107,

legerolighting.com